

polarizer

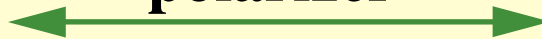

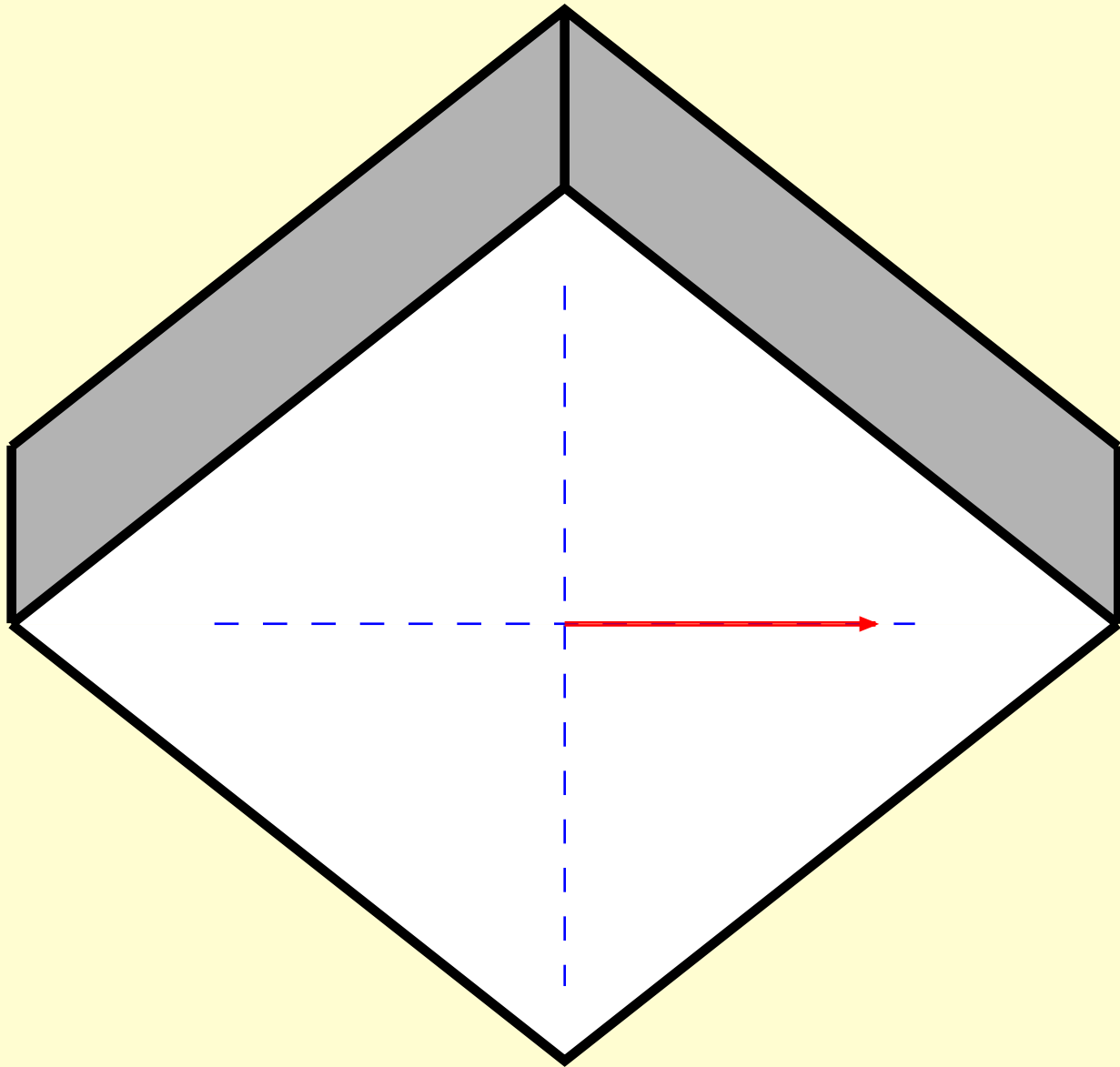

polarizer

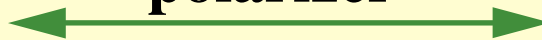

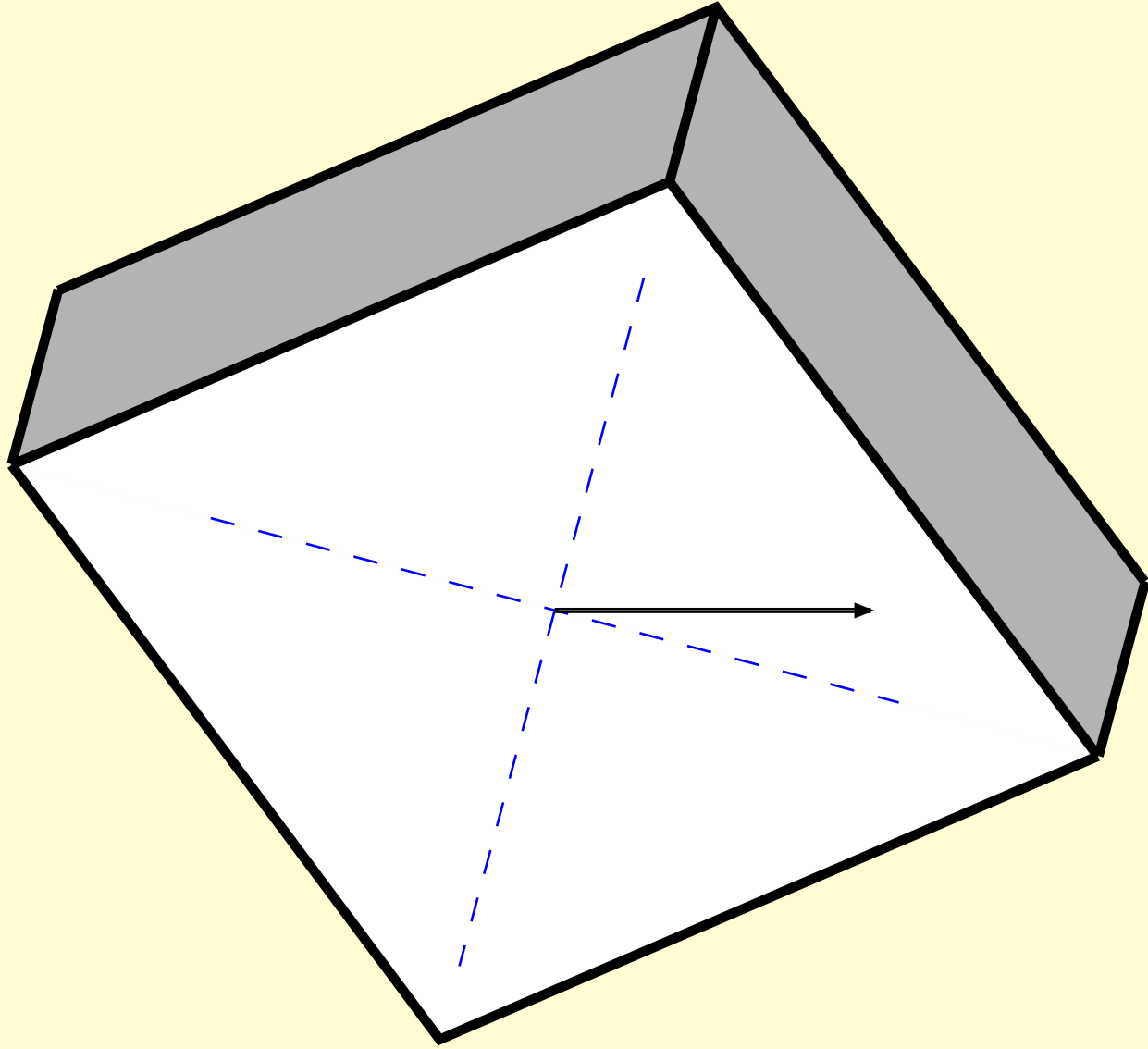

polarizer

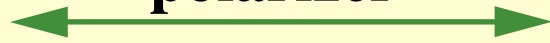

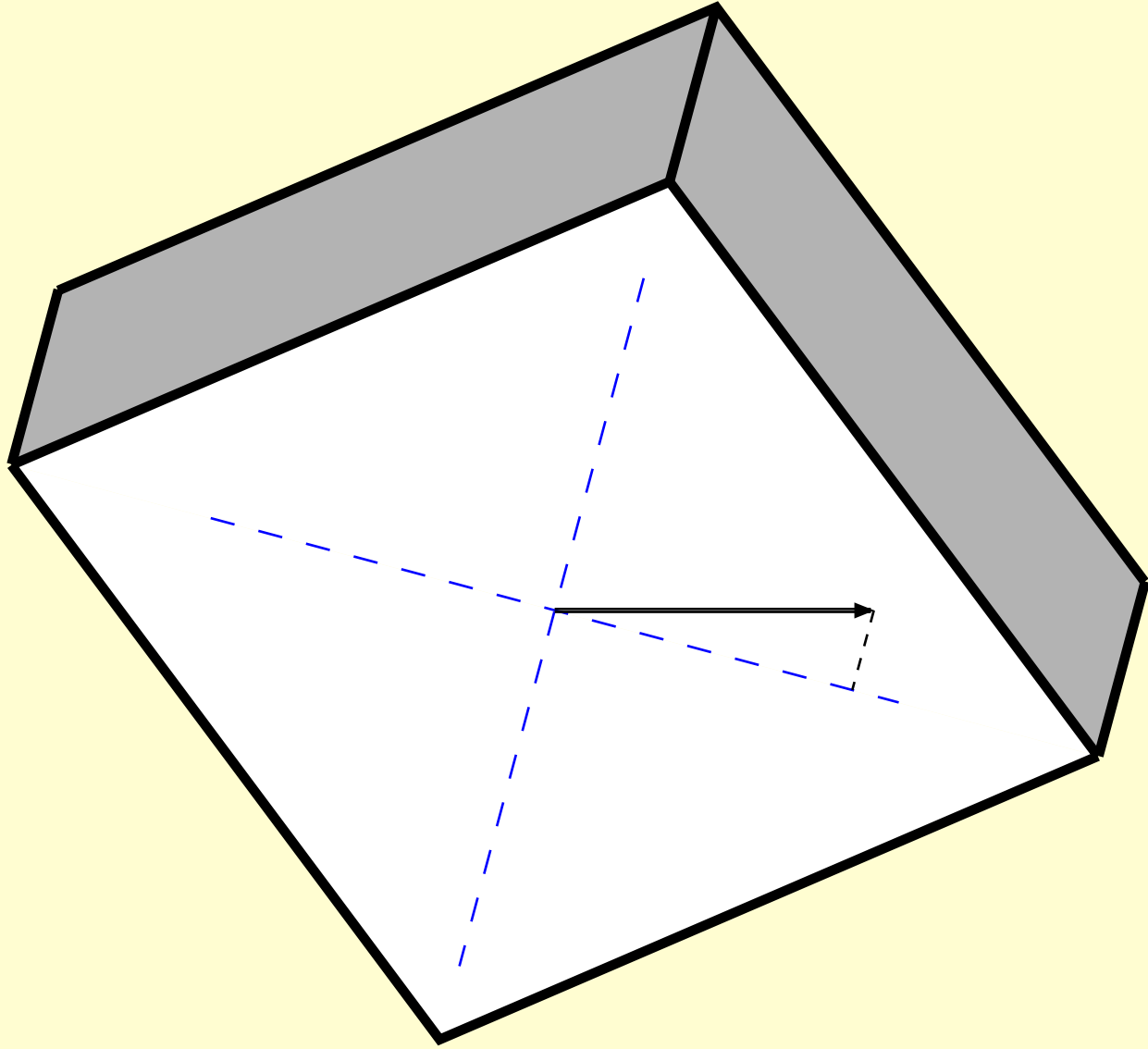

polarizer



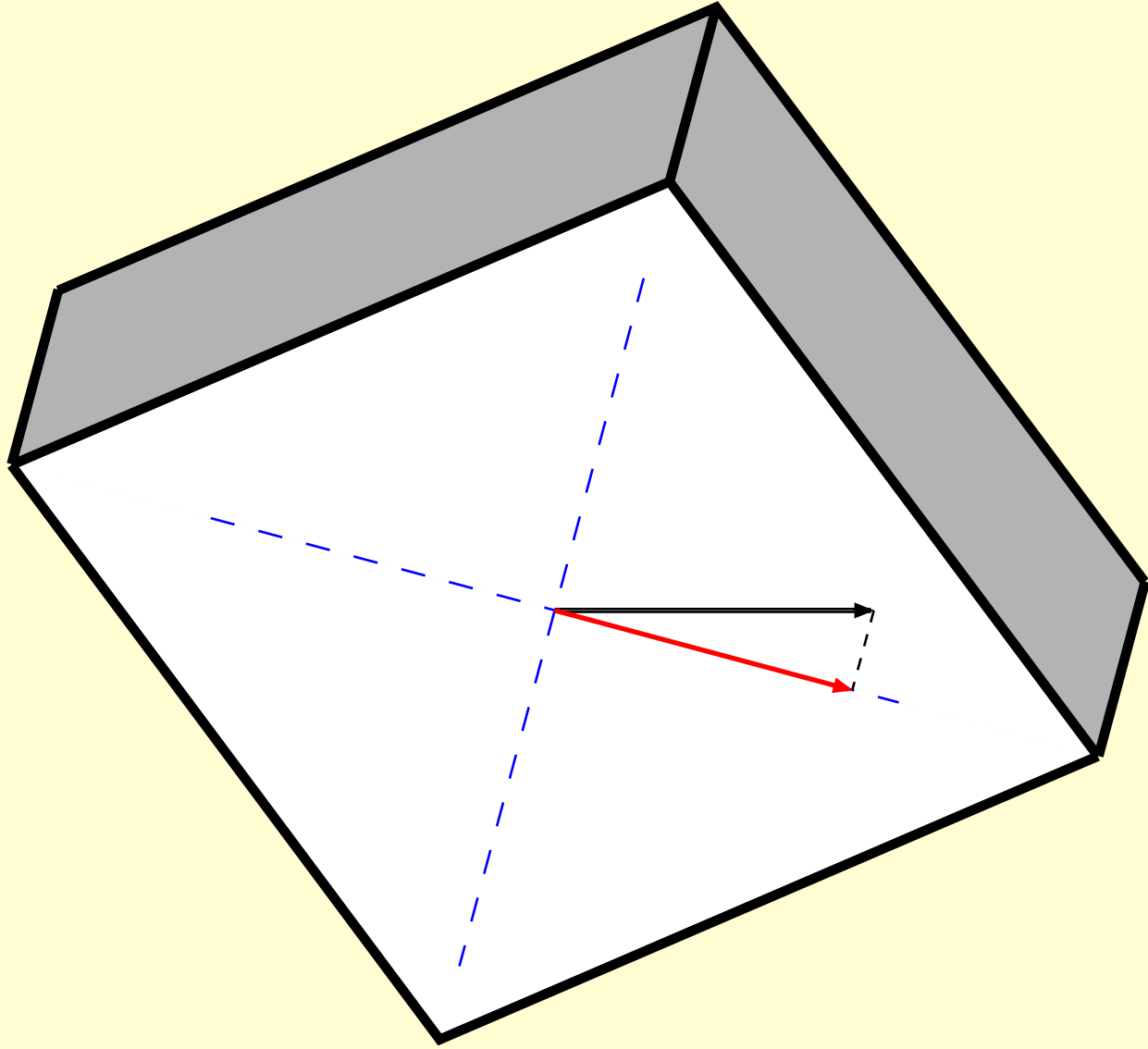

polarizer



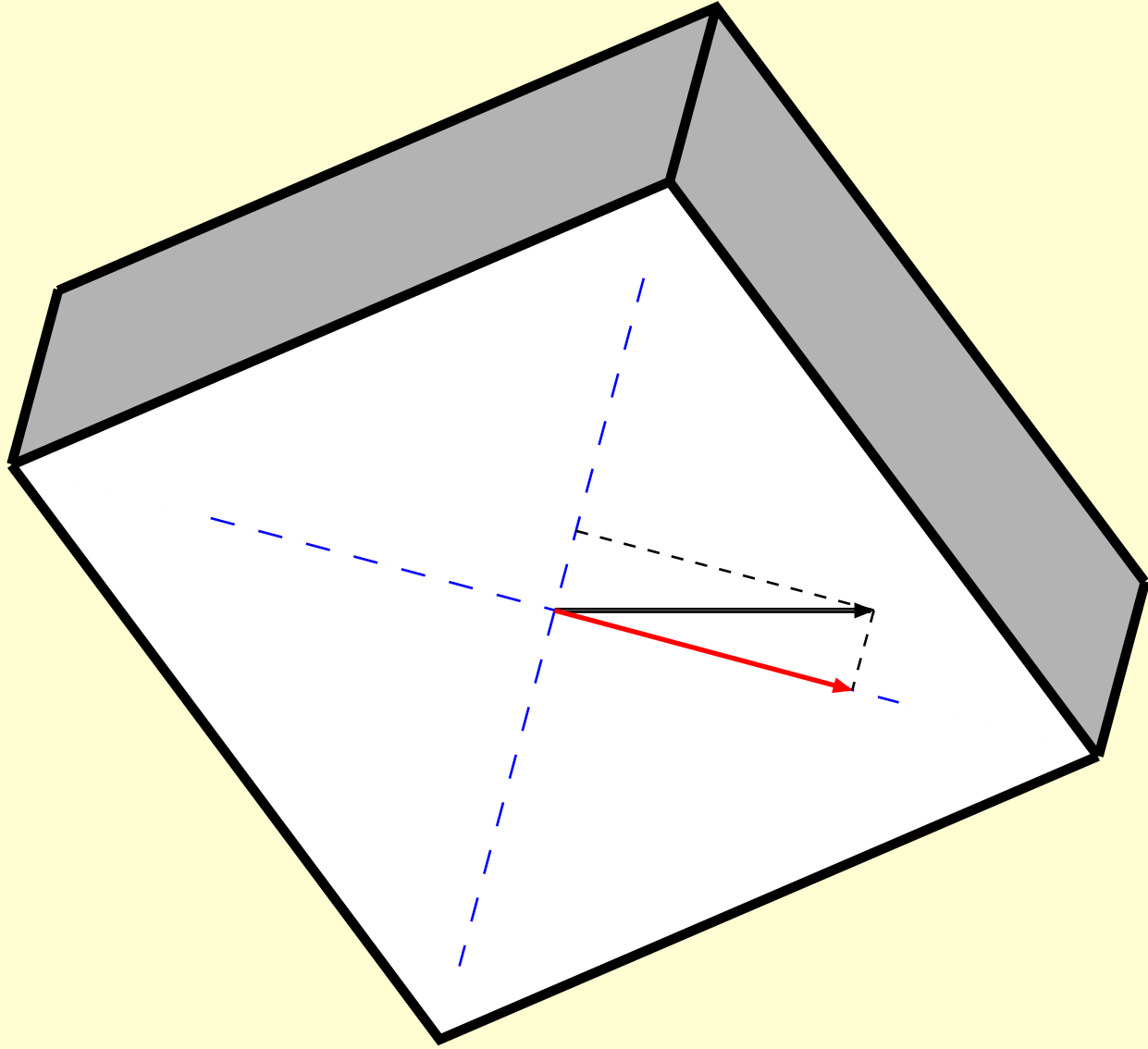

polarizer



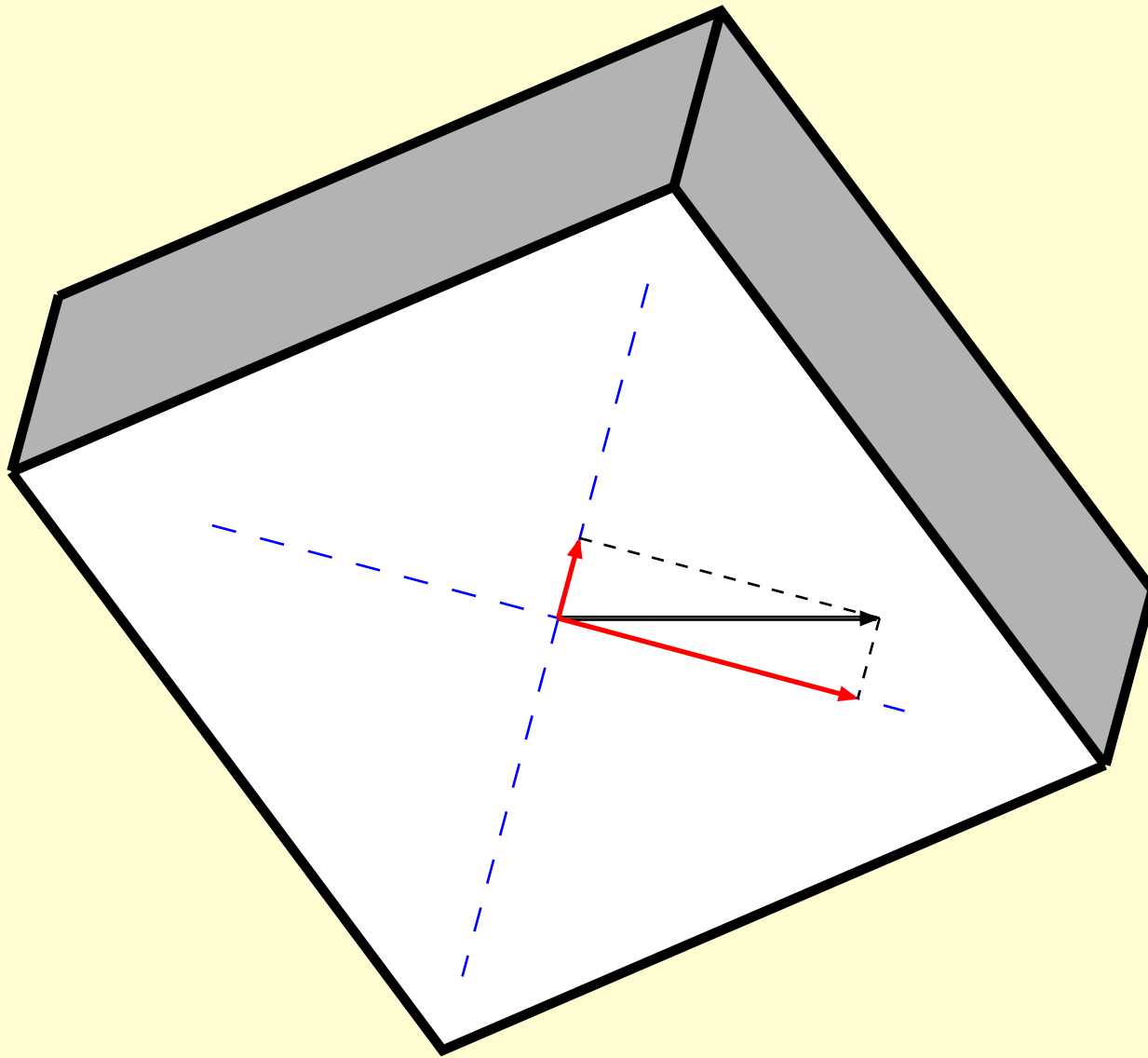

polarizer

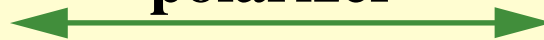

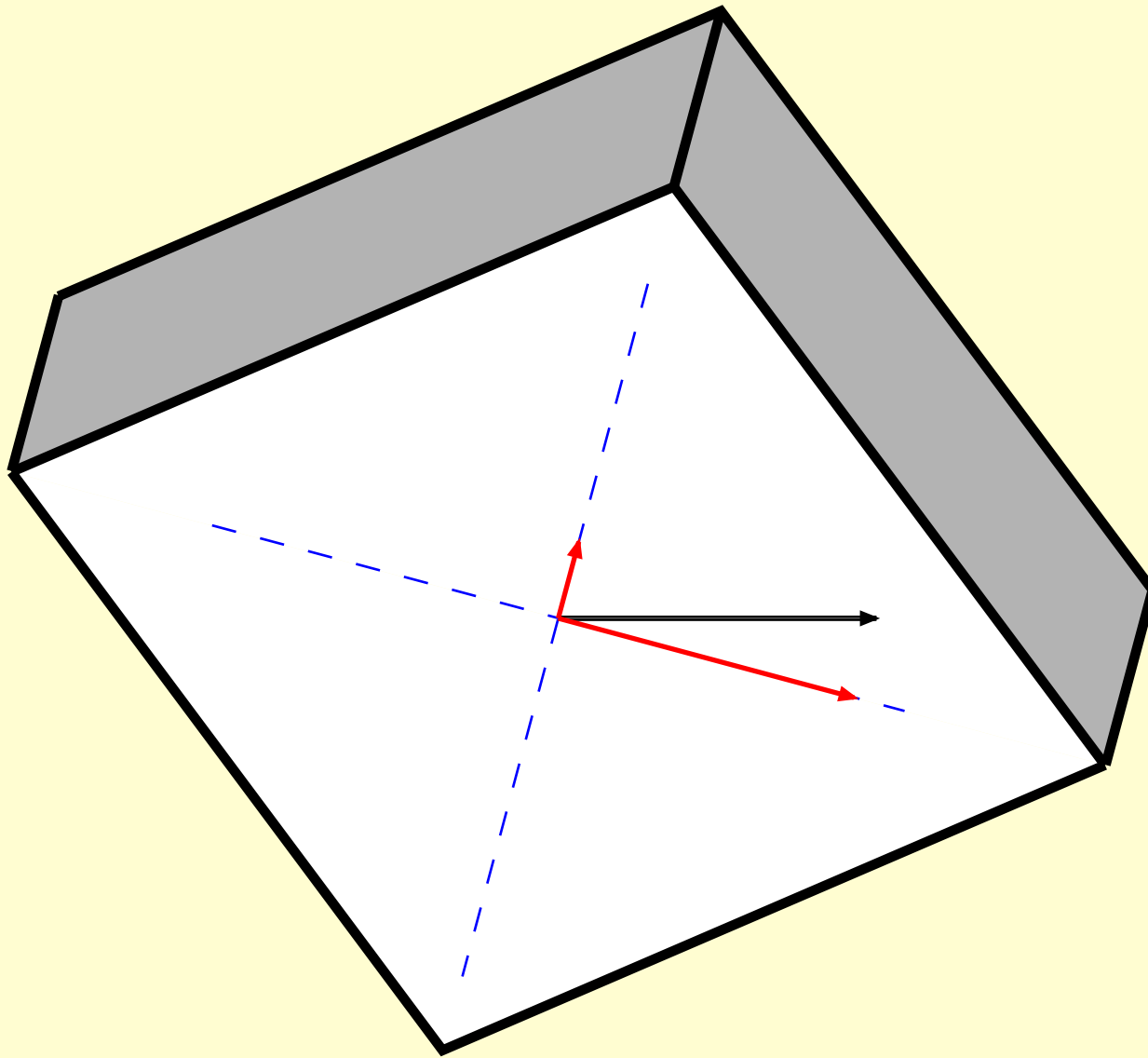

polarizer

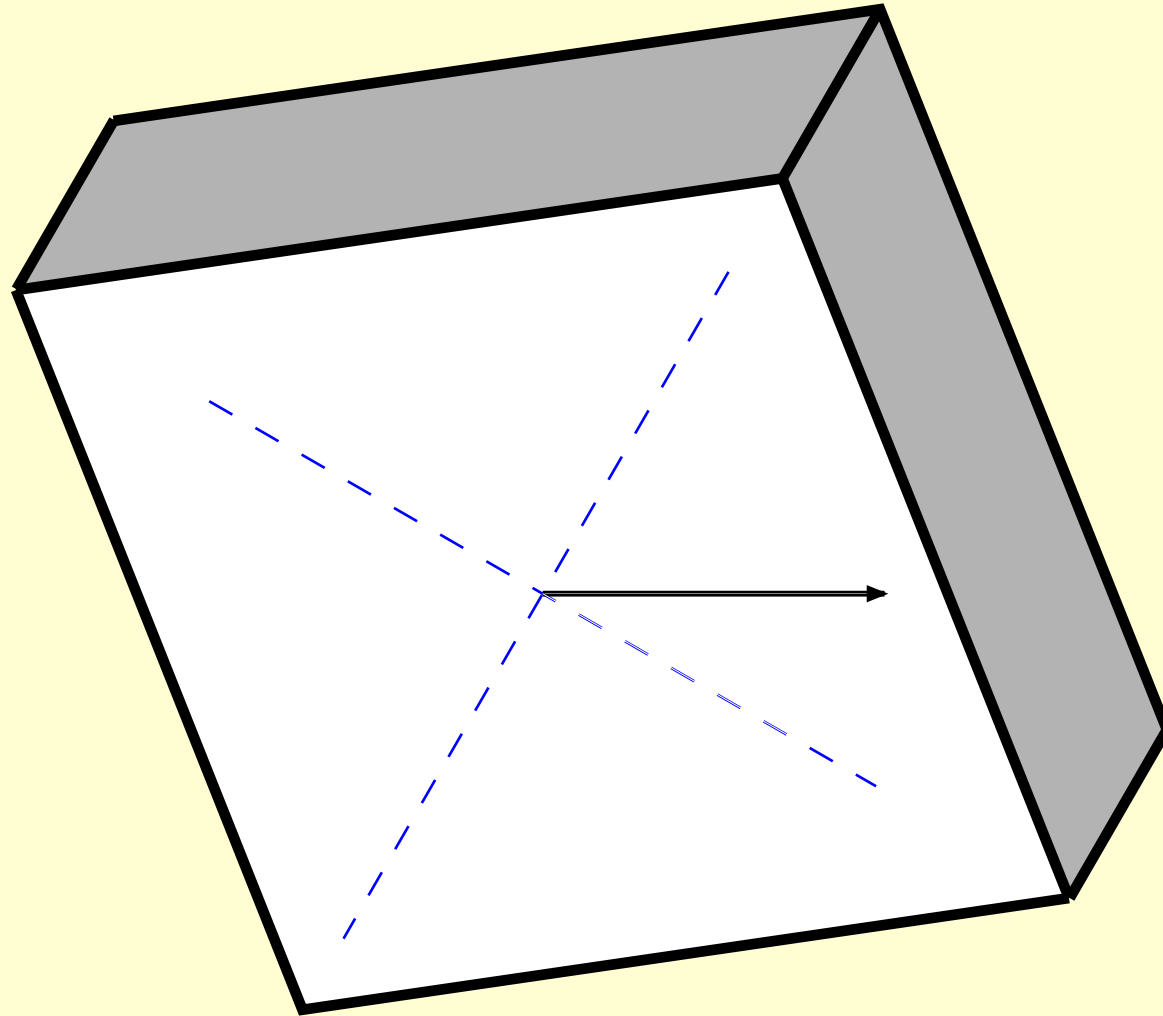

polarizer

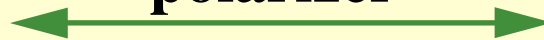

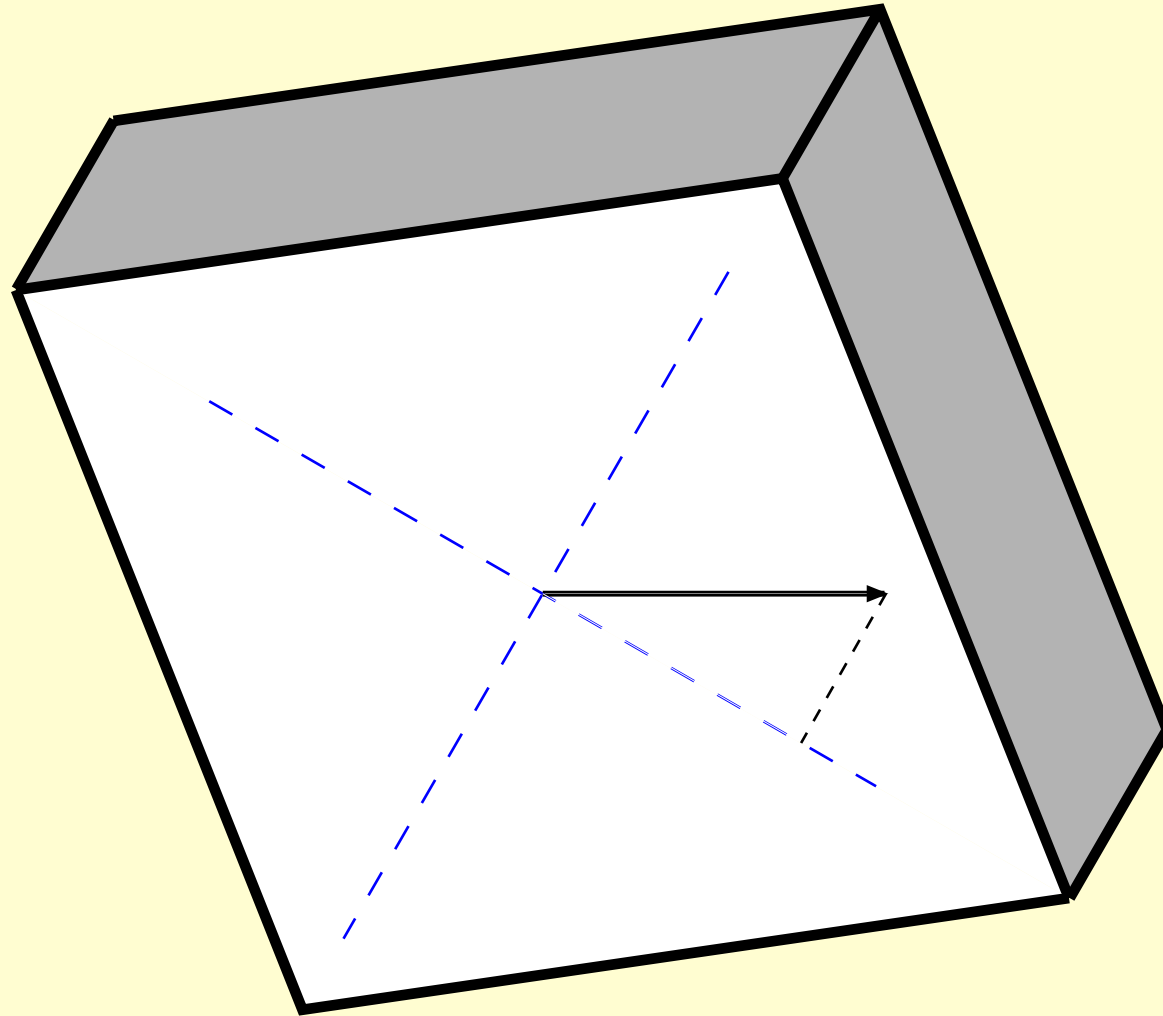

polarizer

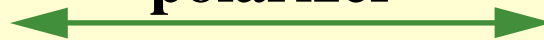

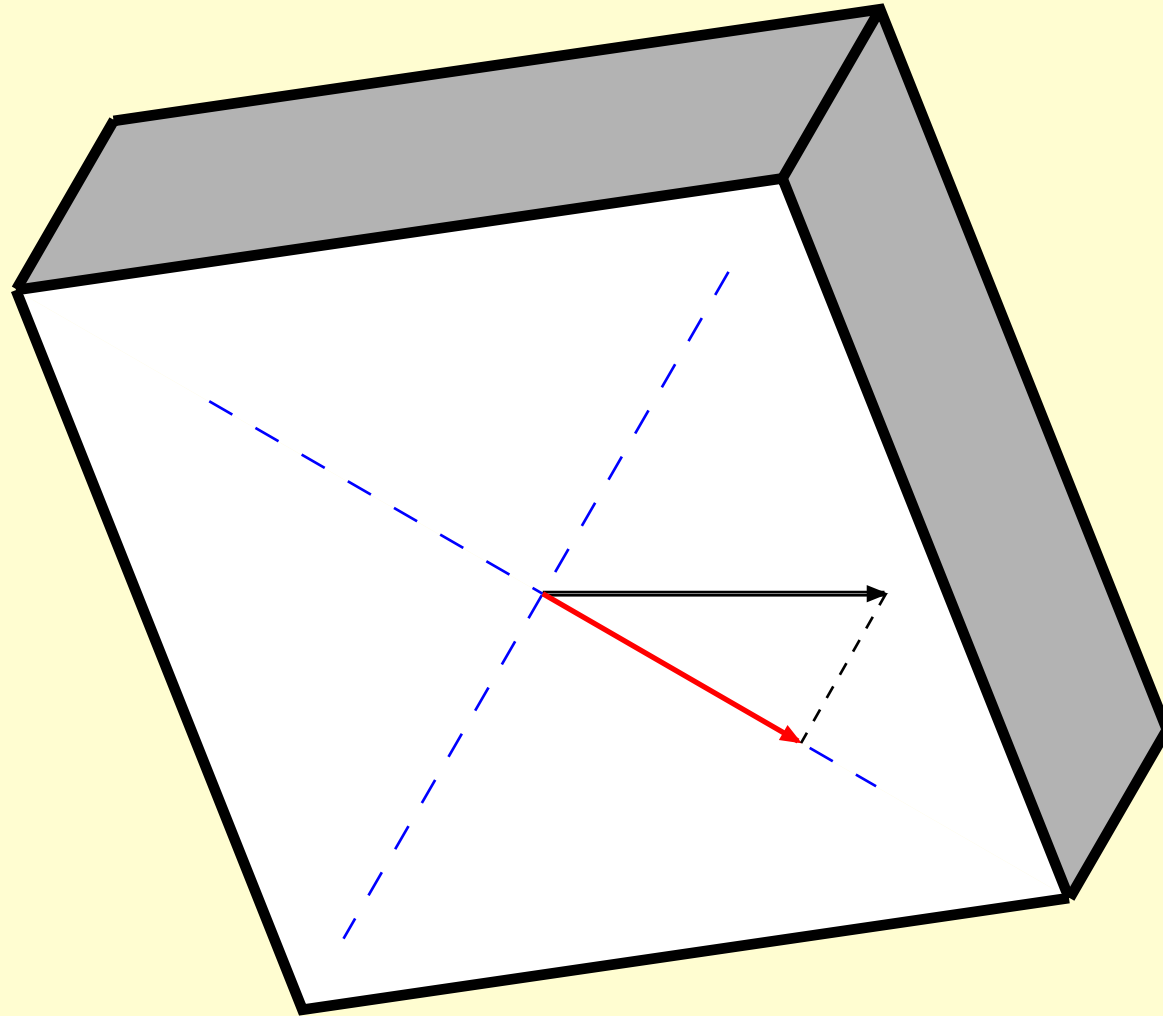

polarizer

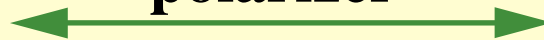

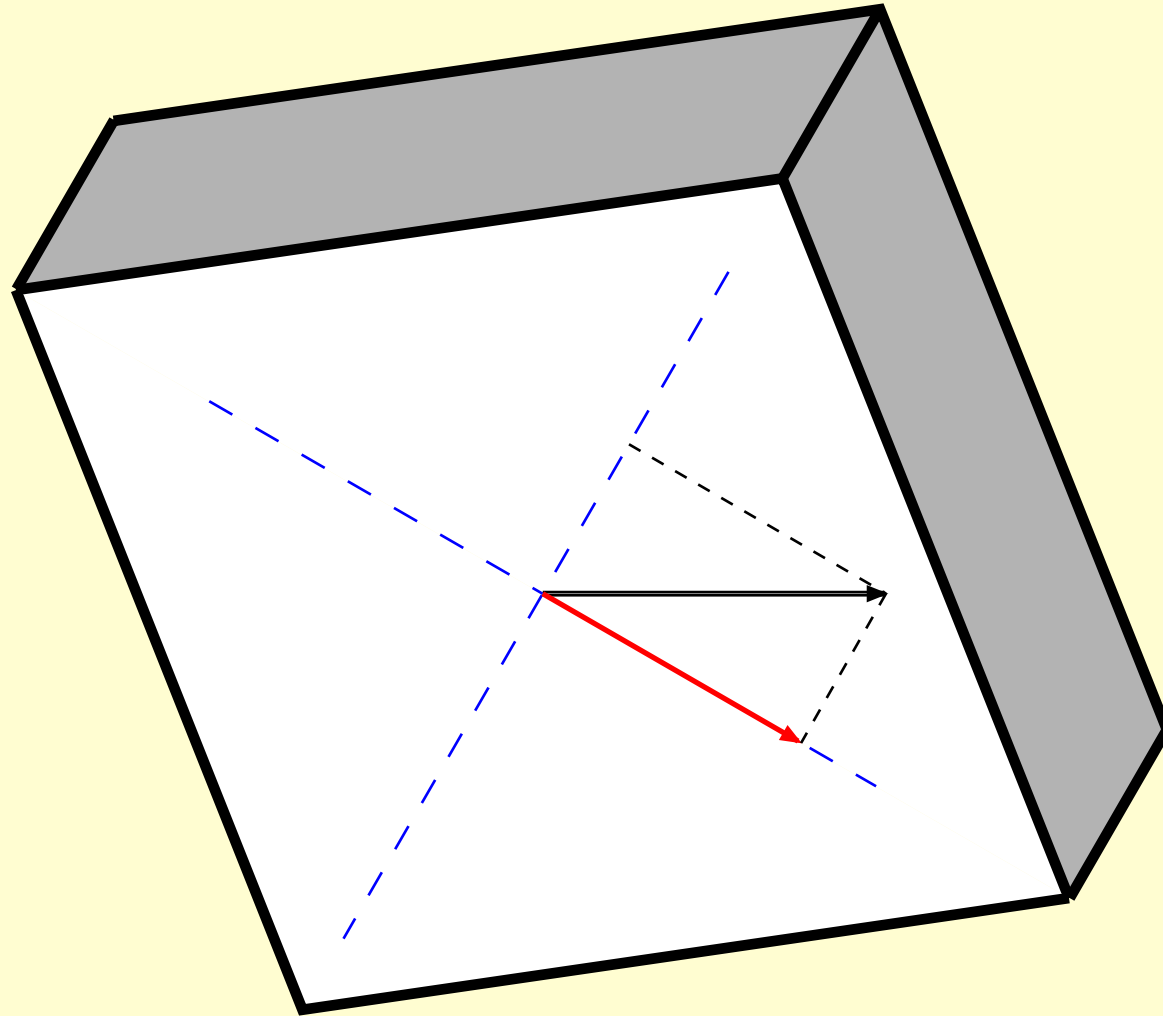

polarizer

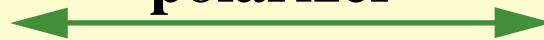

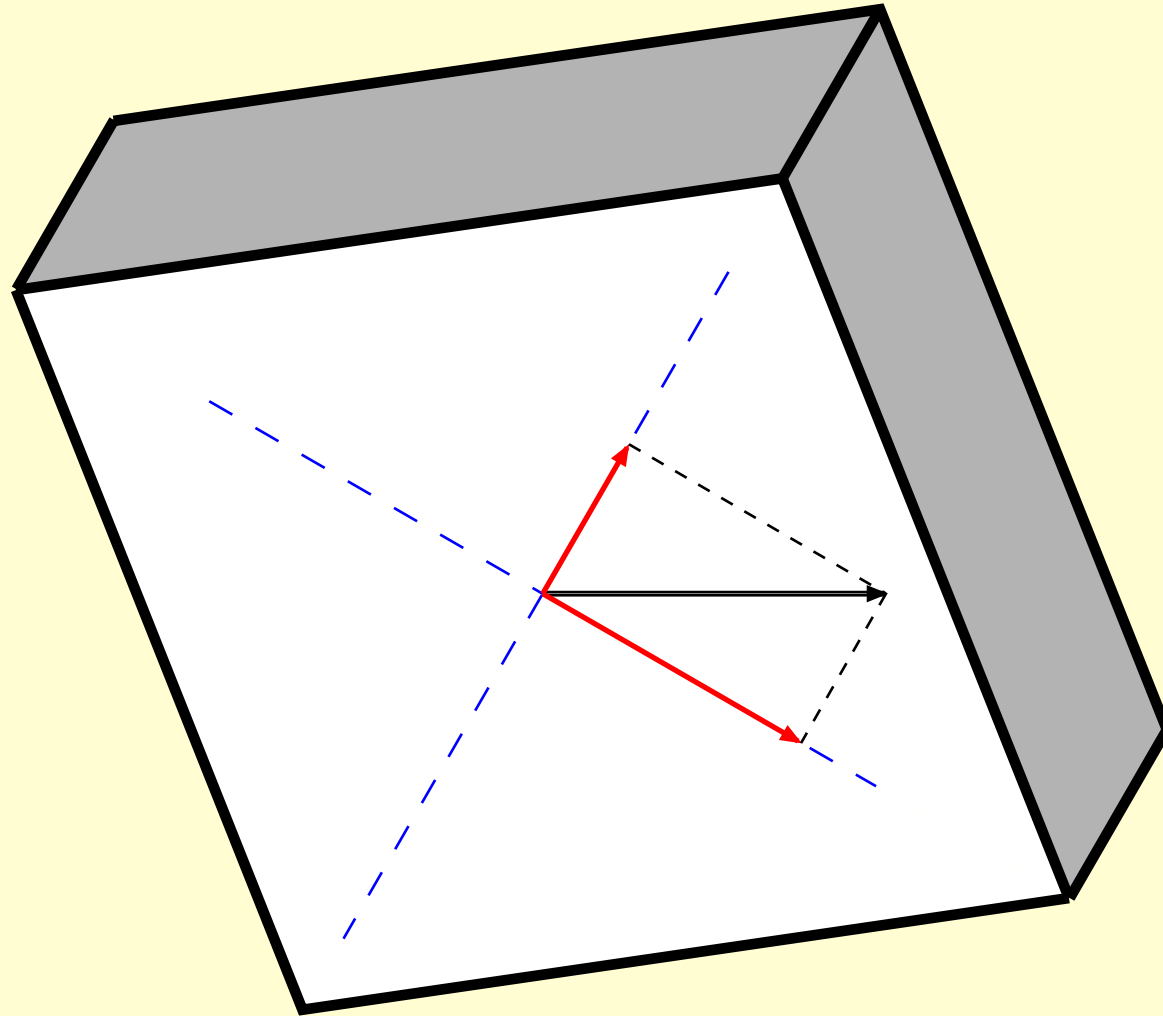

polarizer



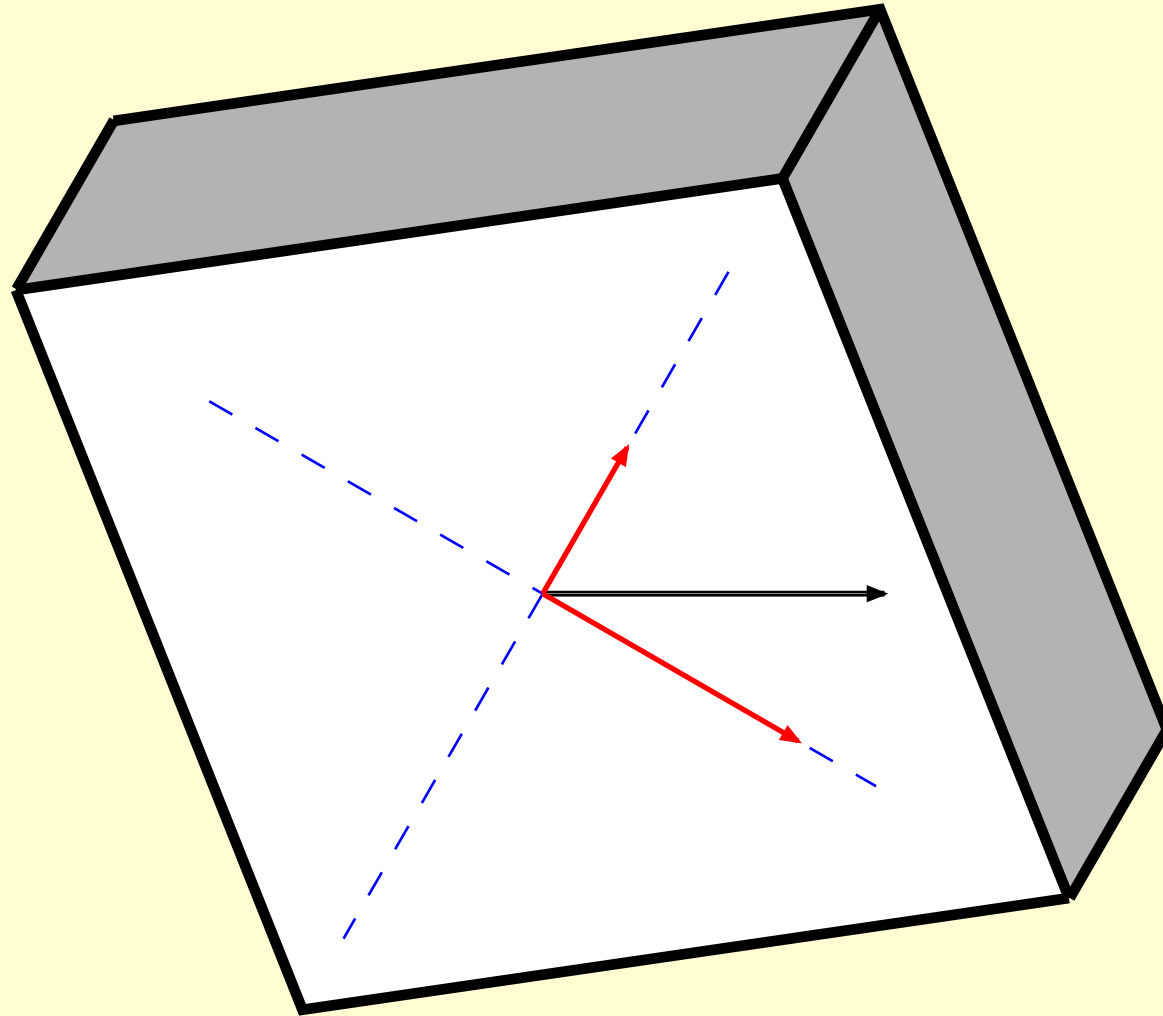

polarizer



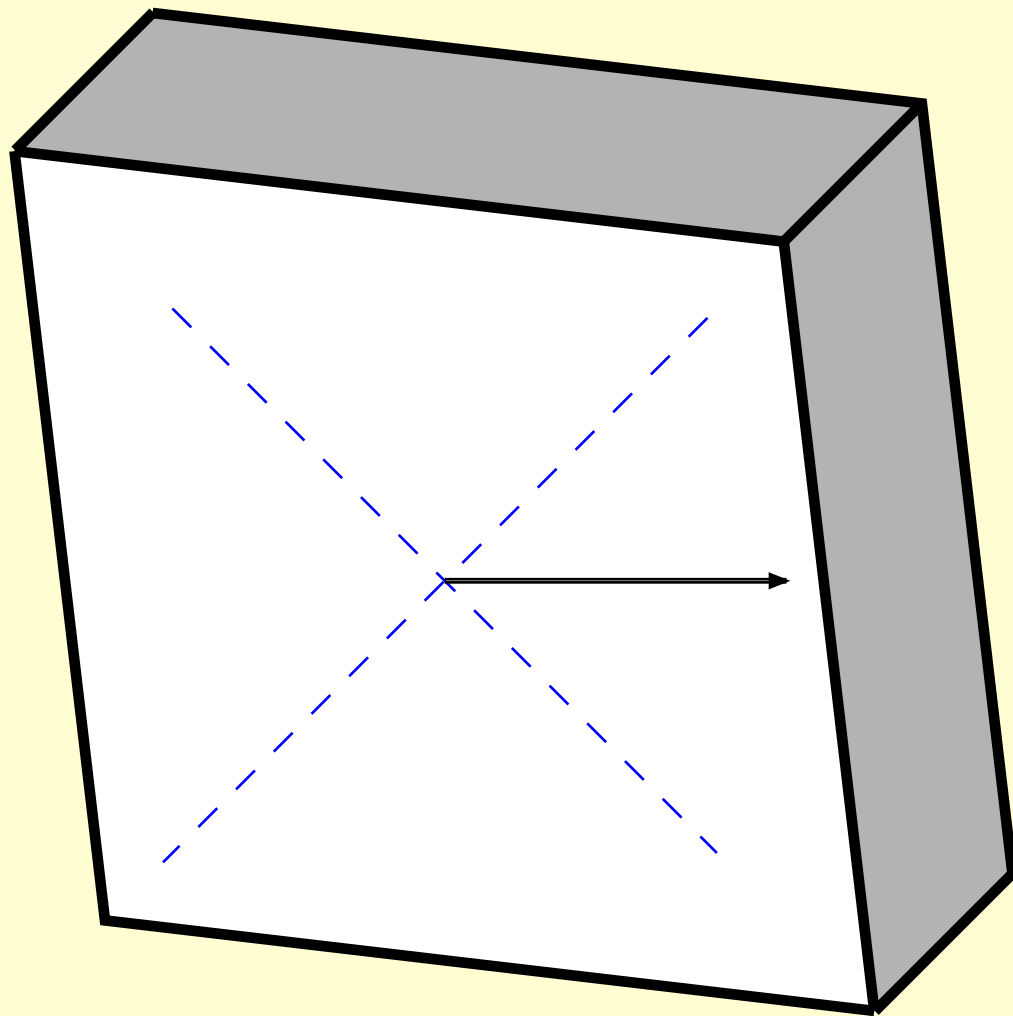

polarizer



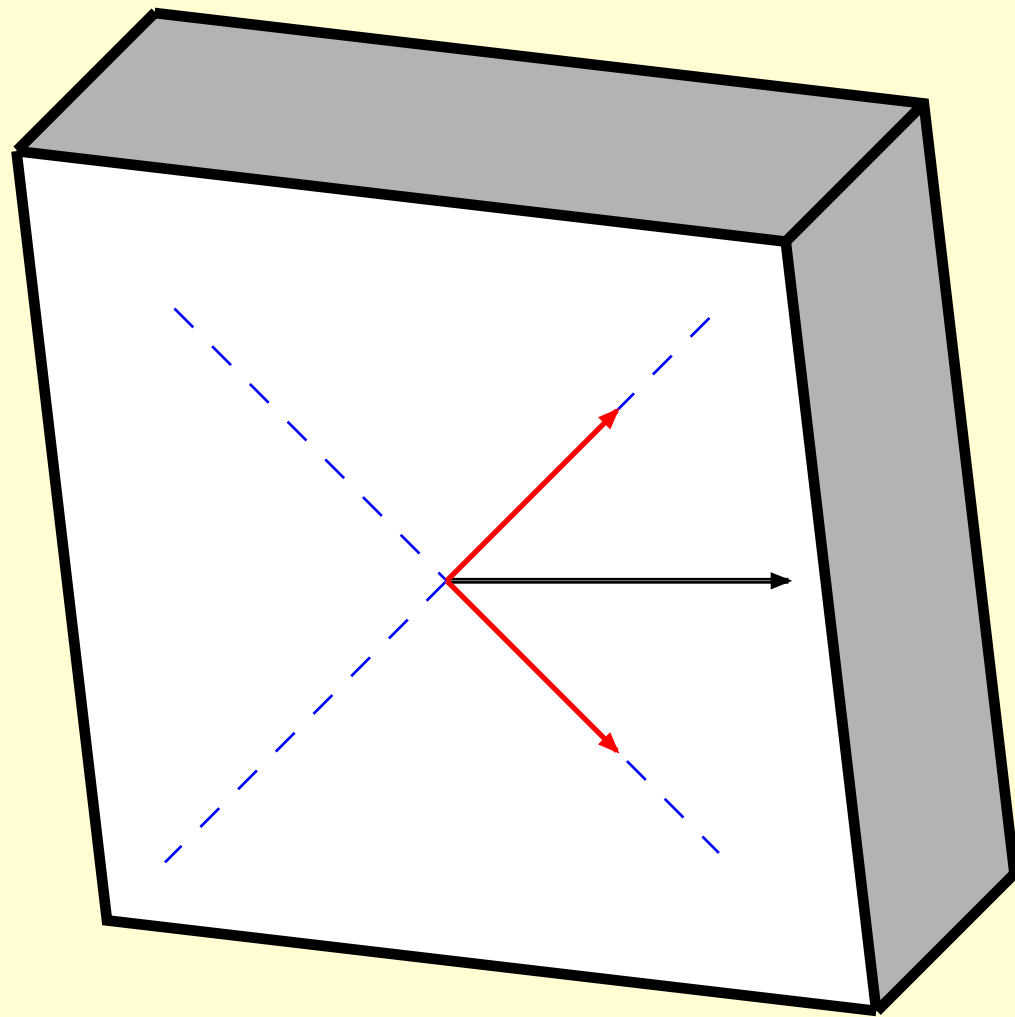

polarizer



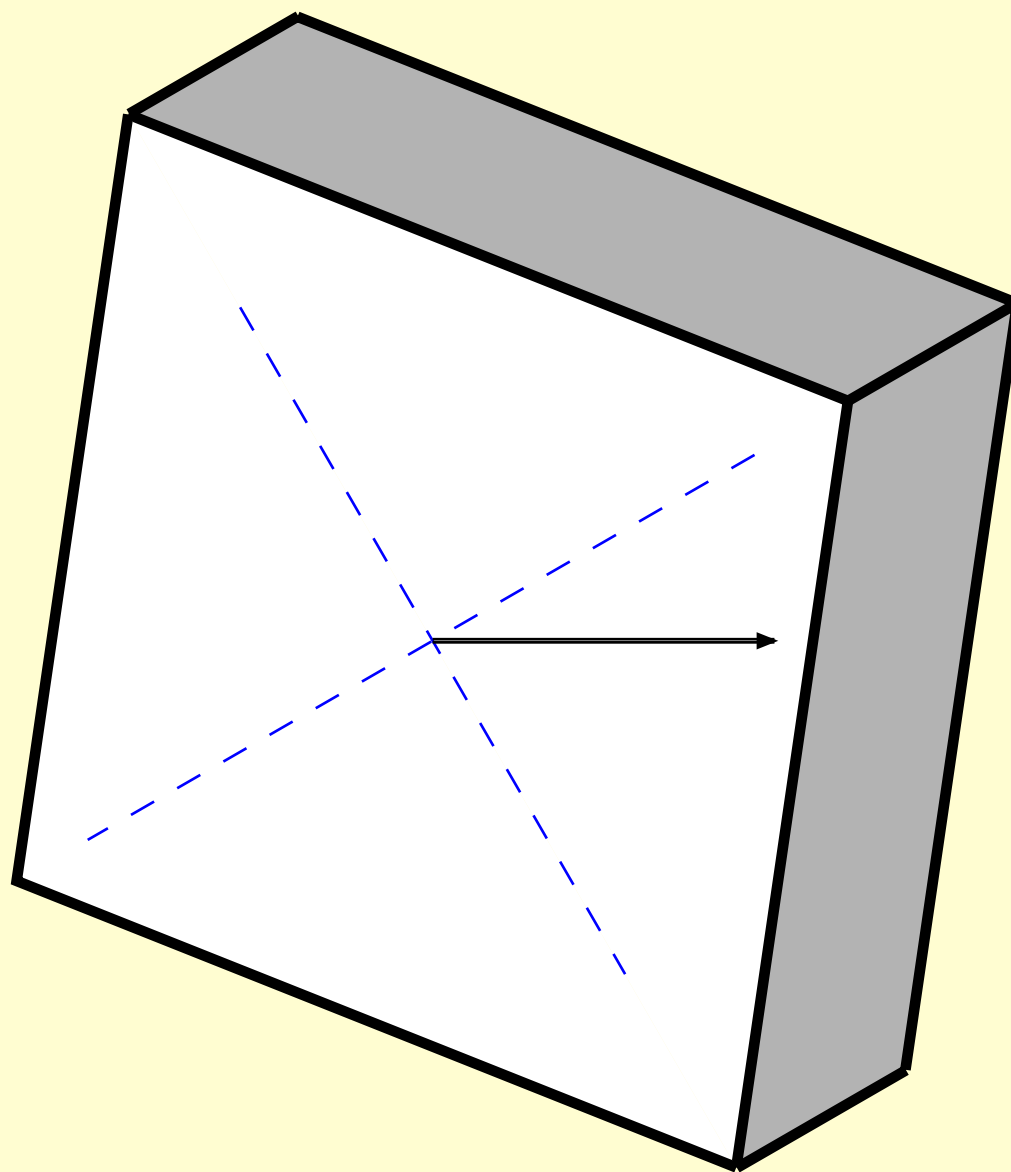

polarizer



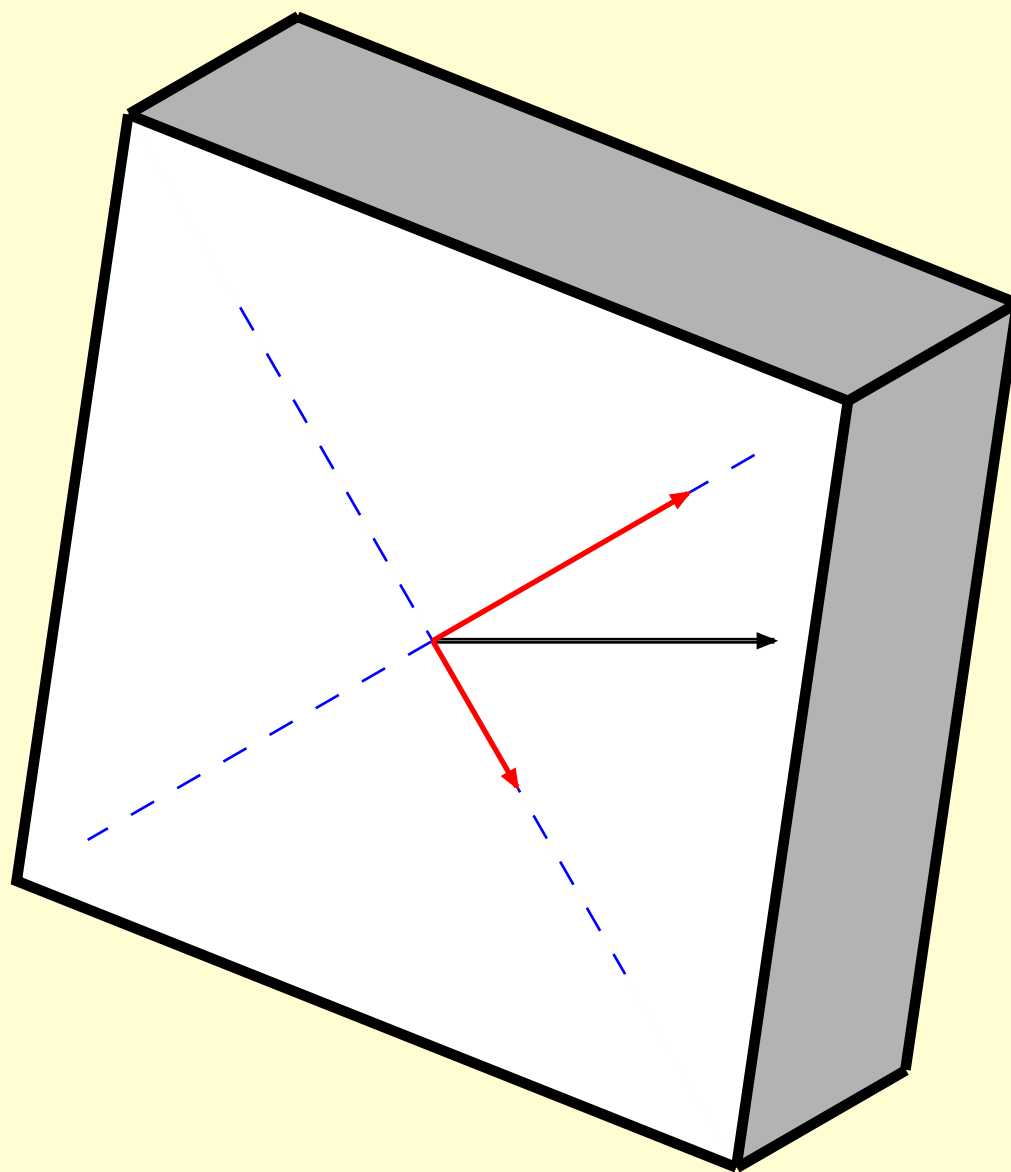

polarizer



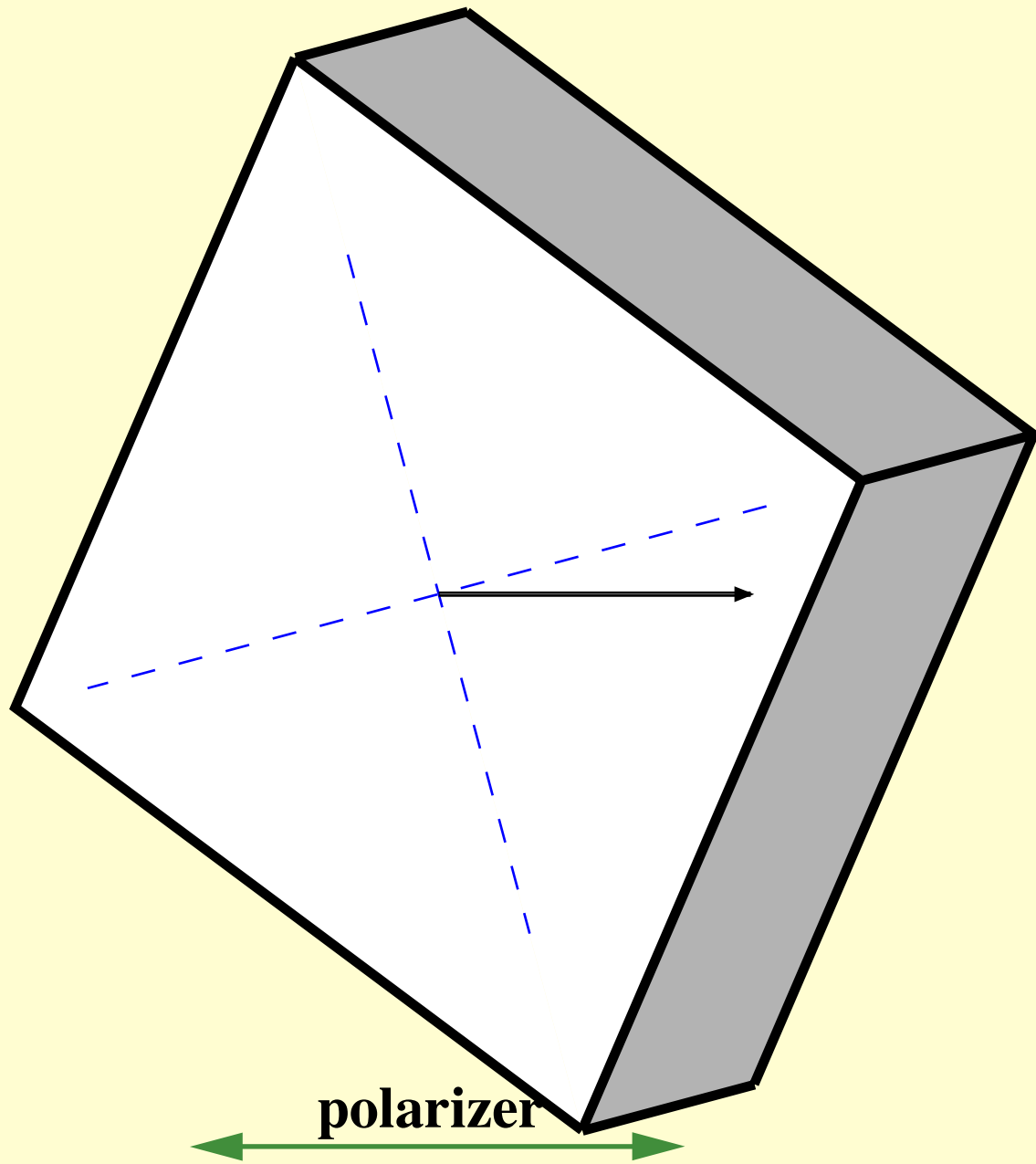

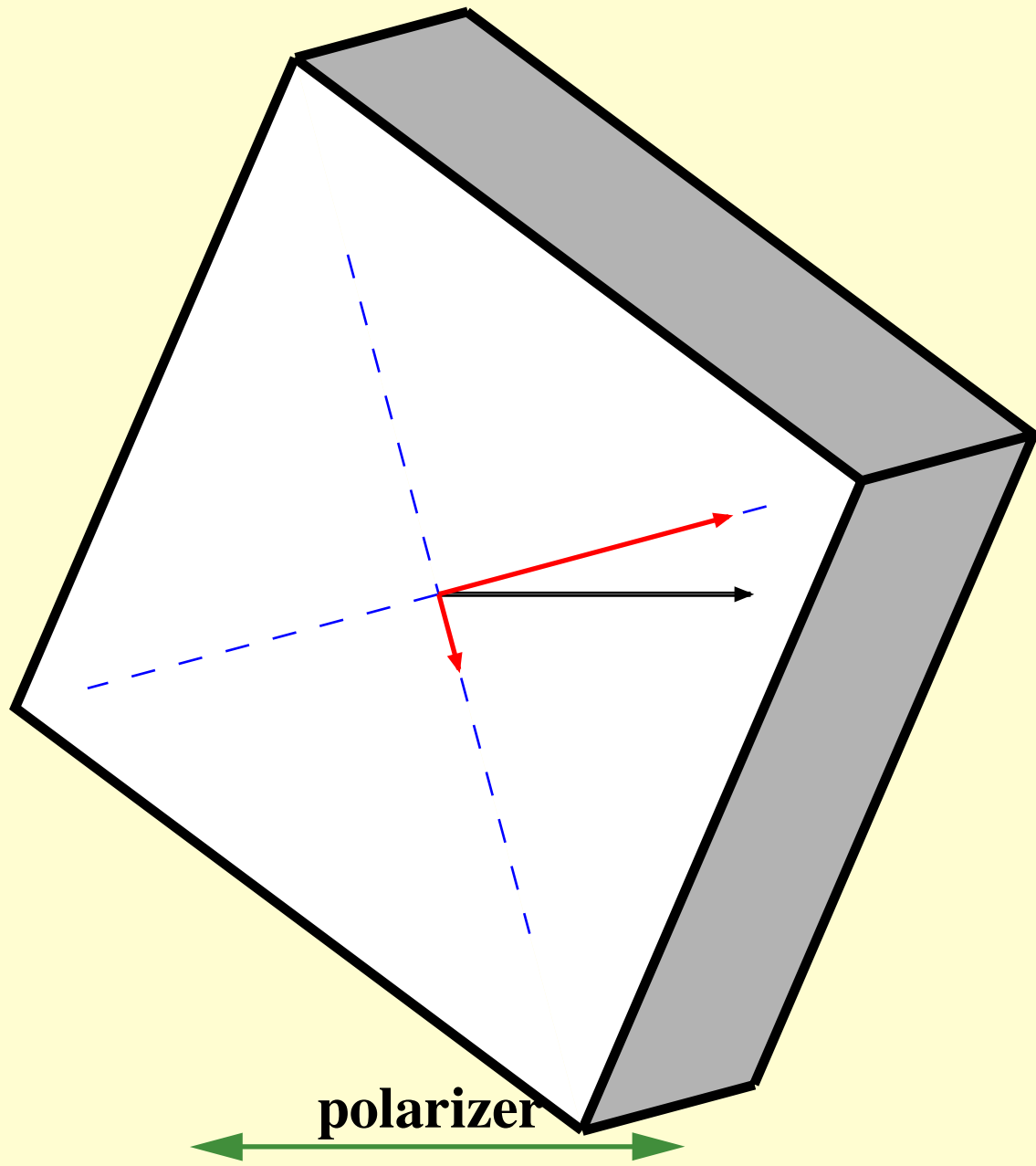

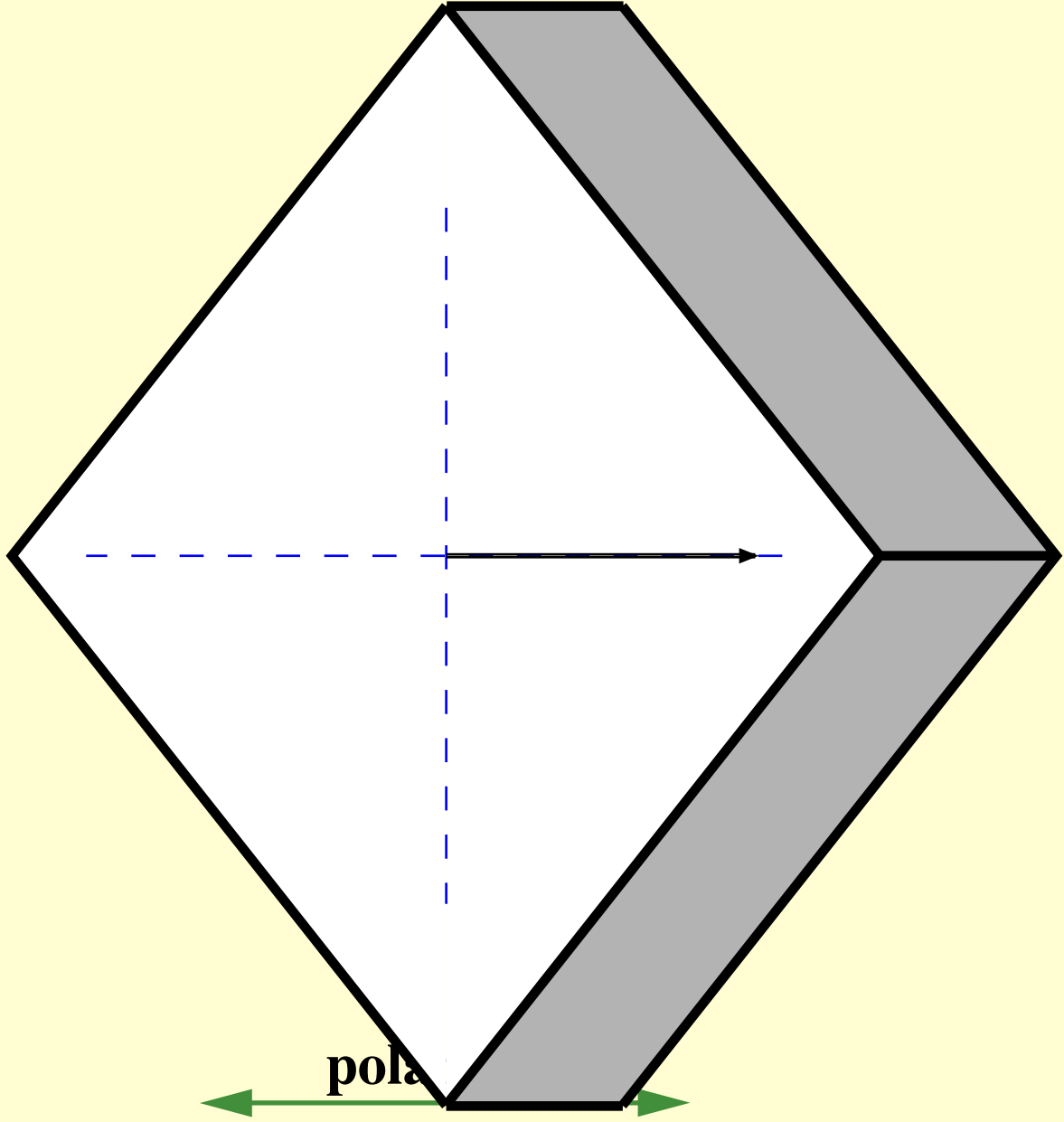

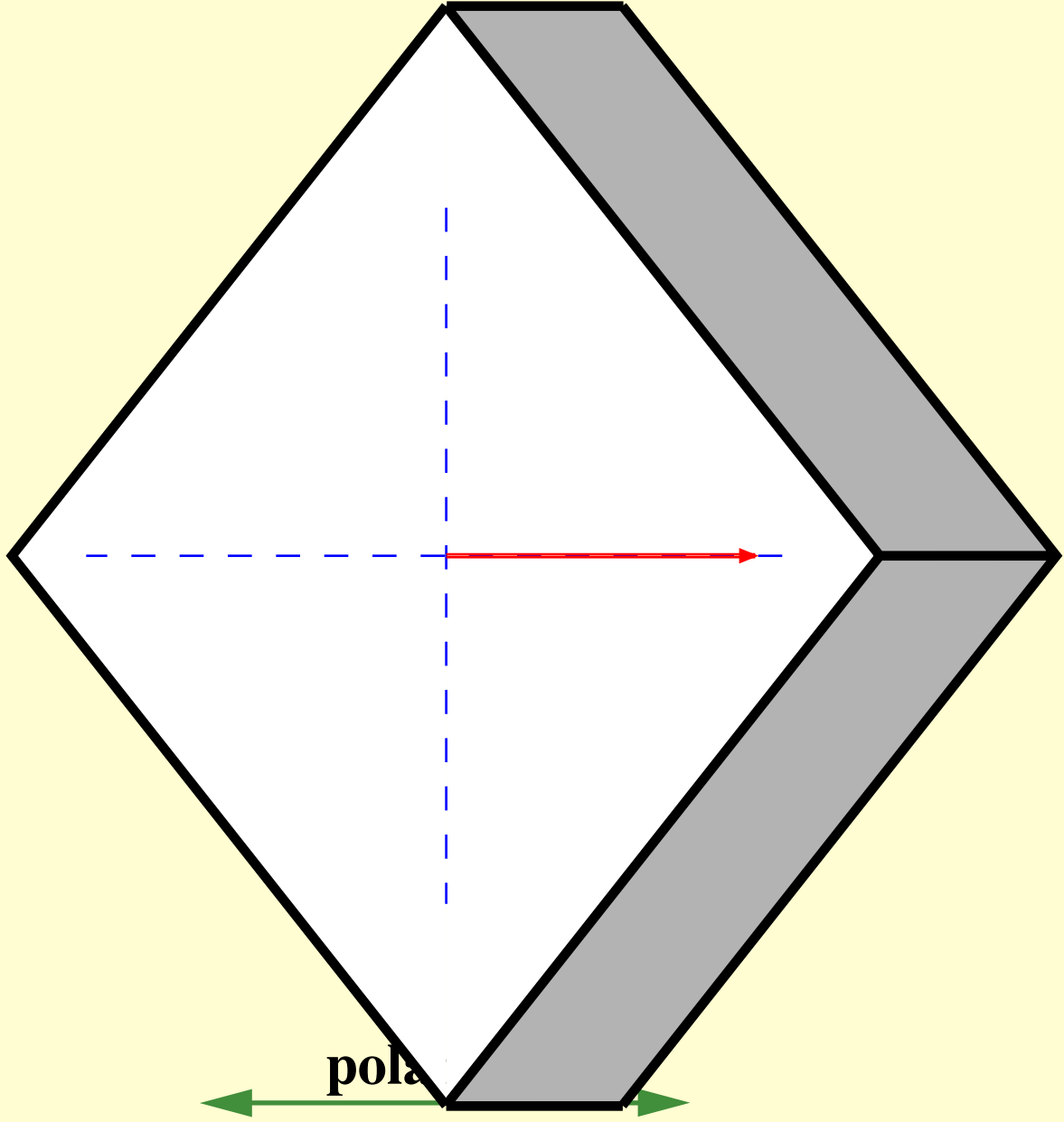

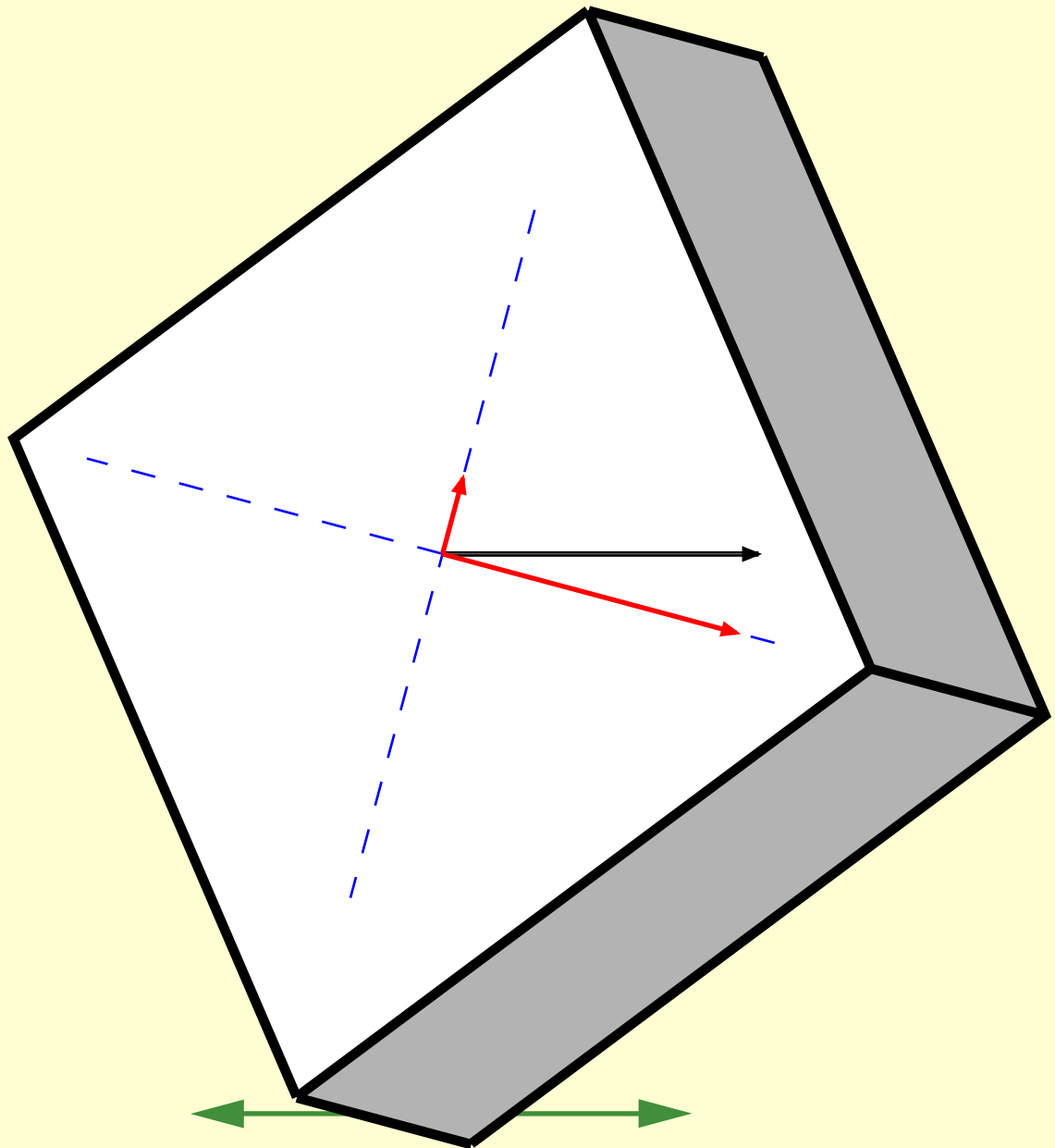

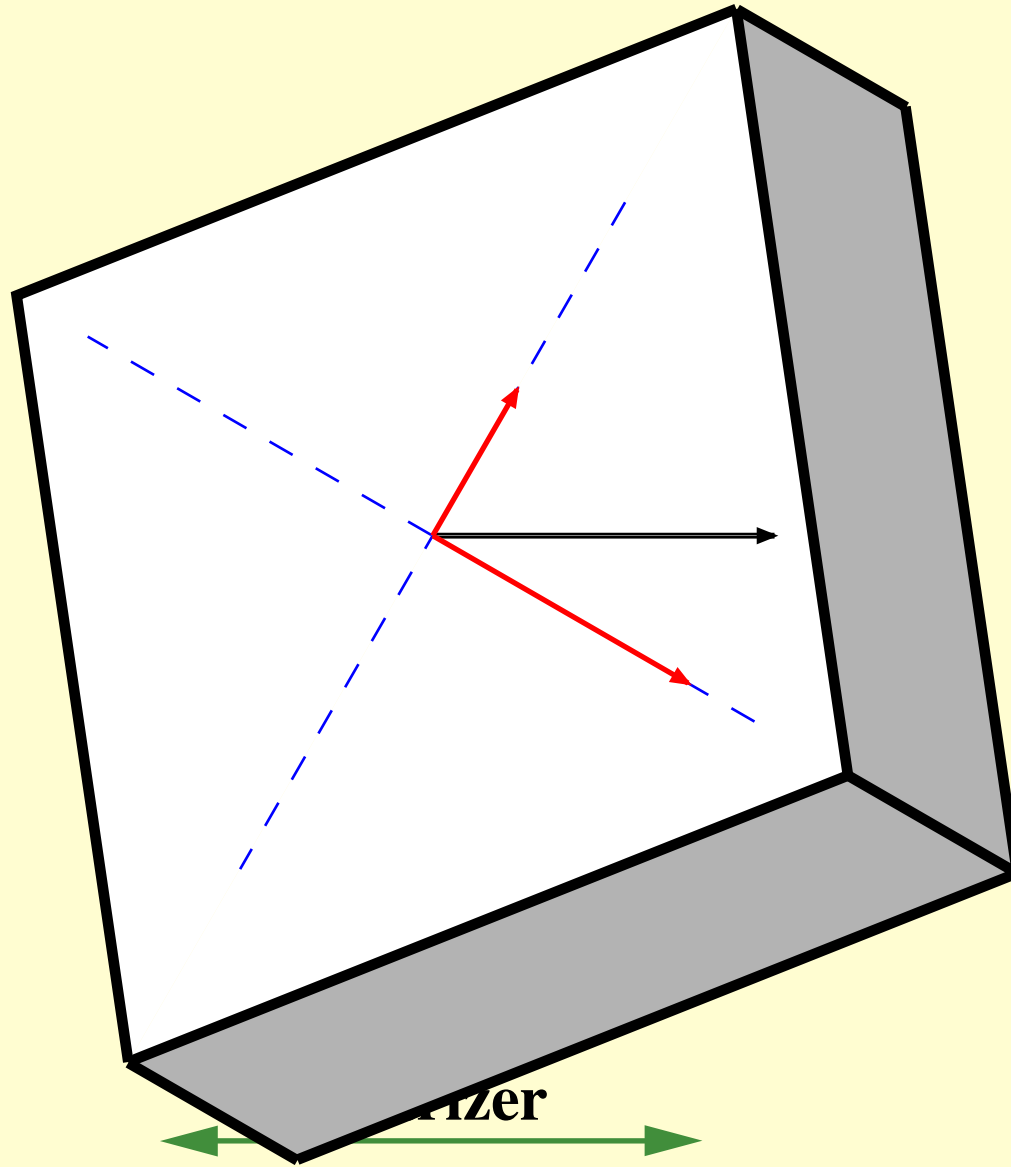

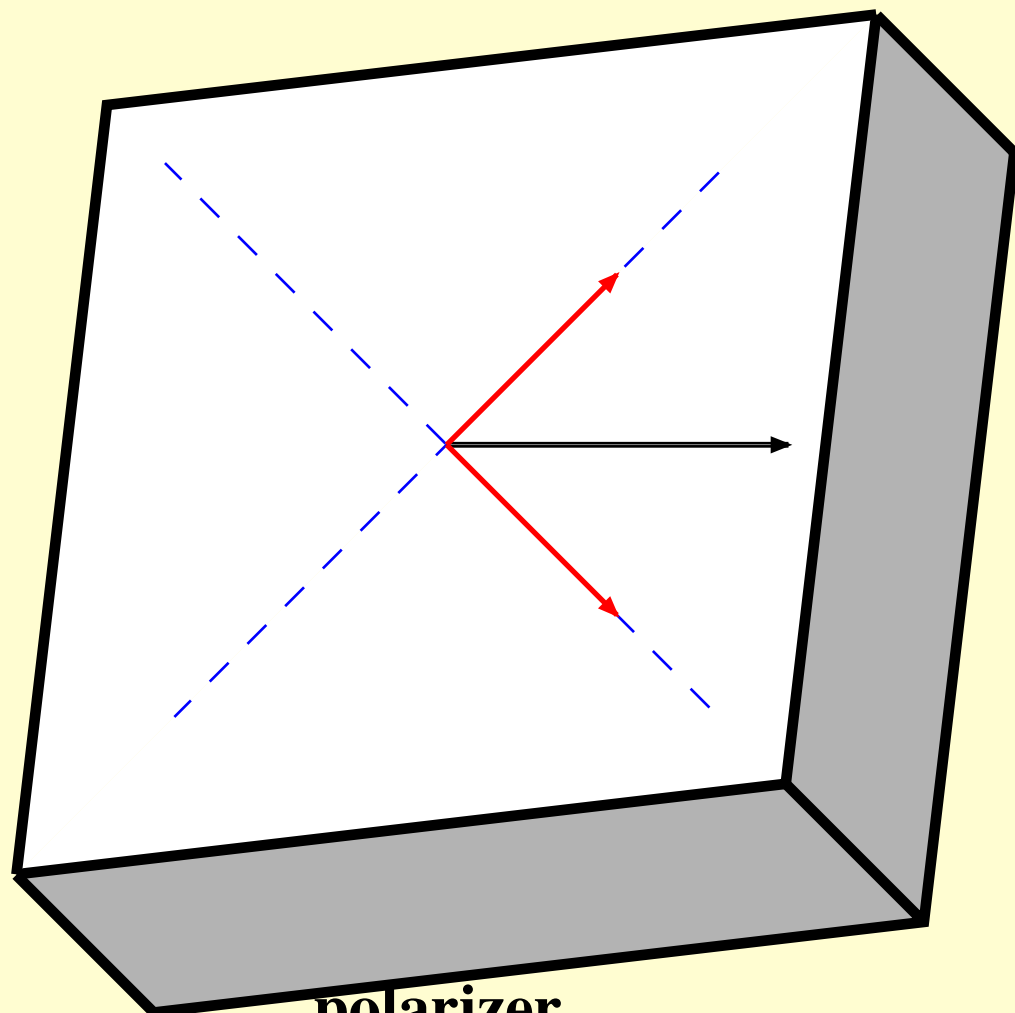

polarizer

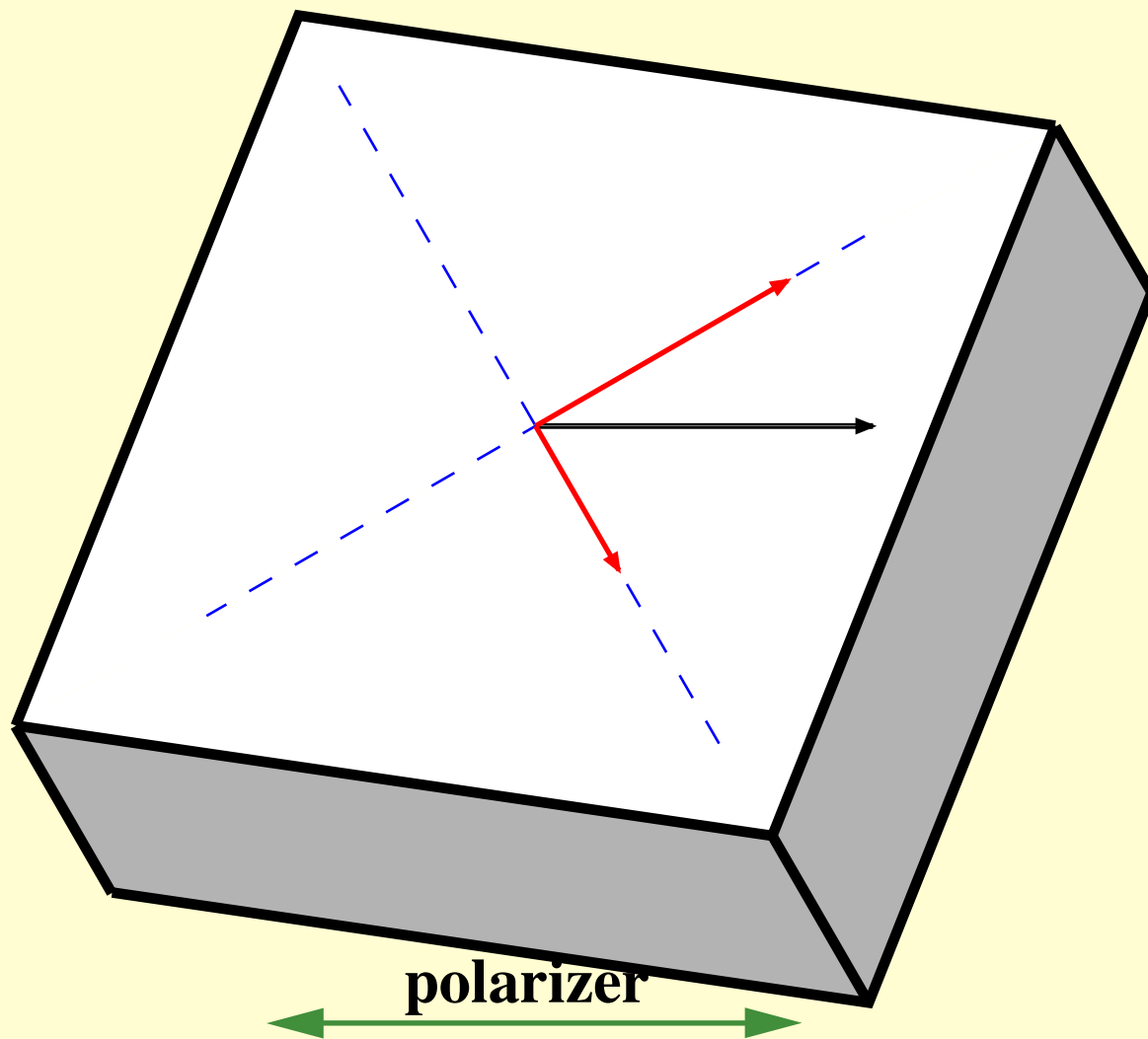

polarizer

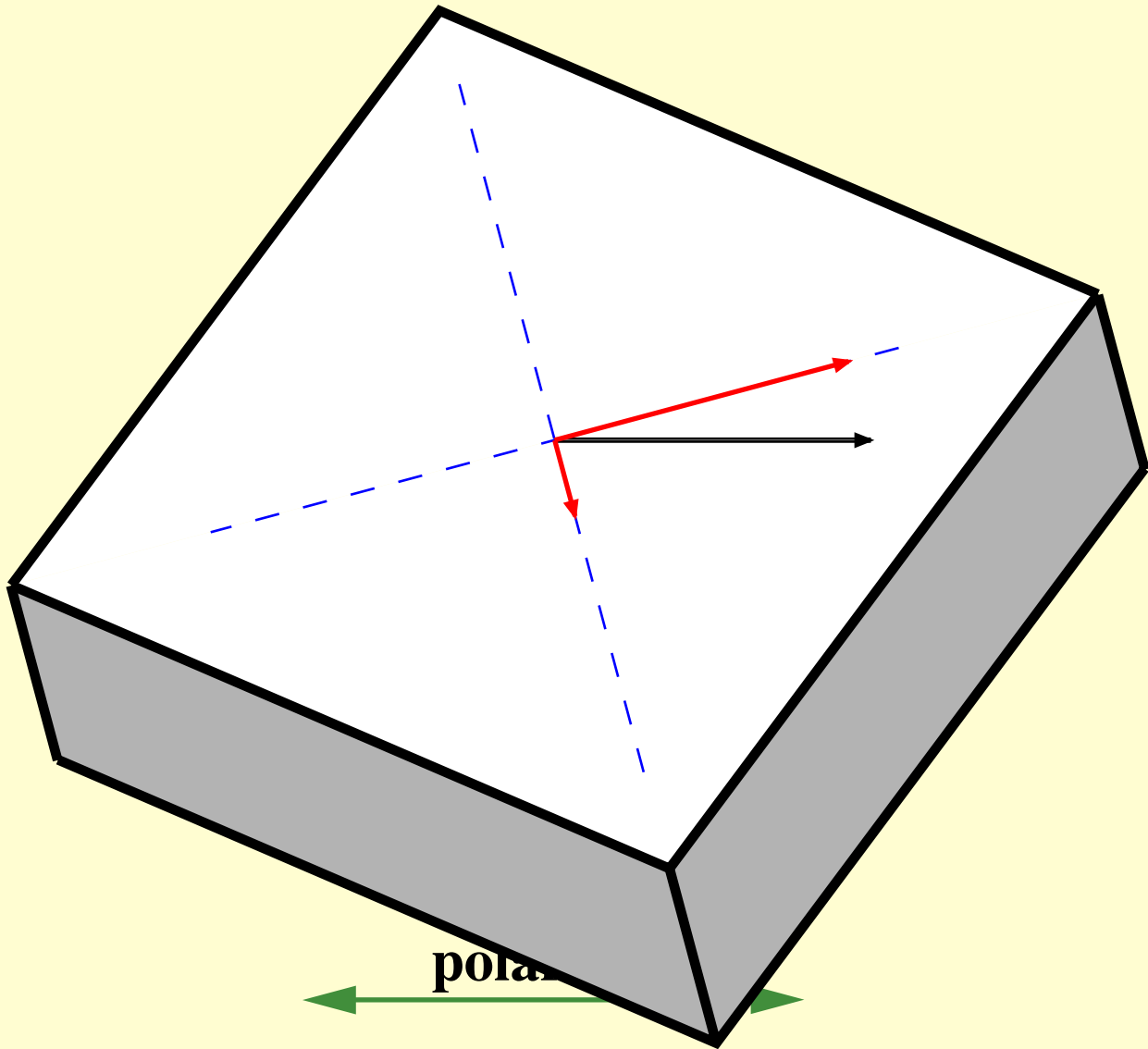

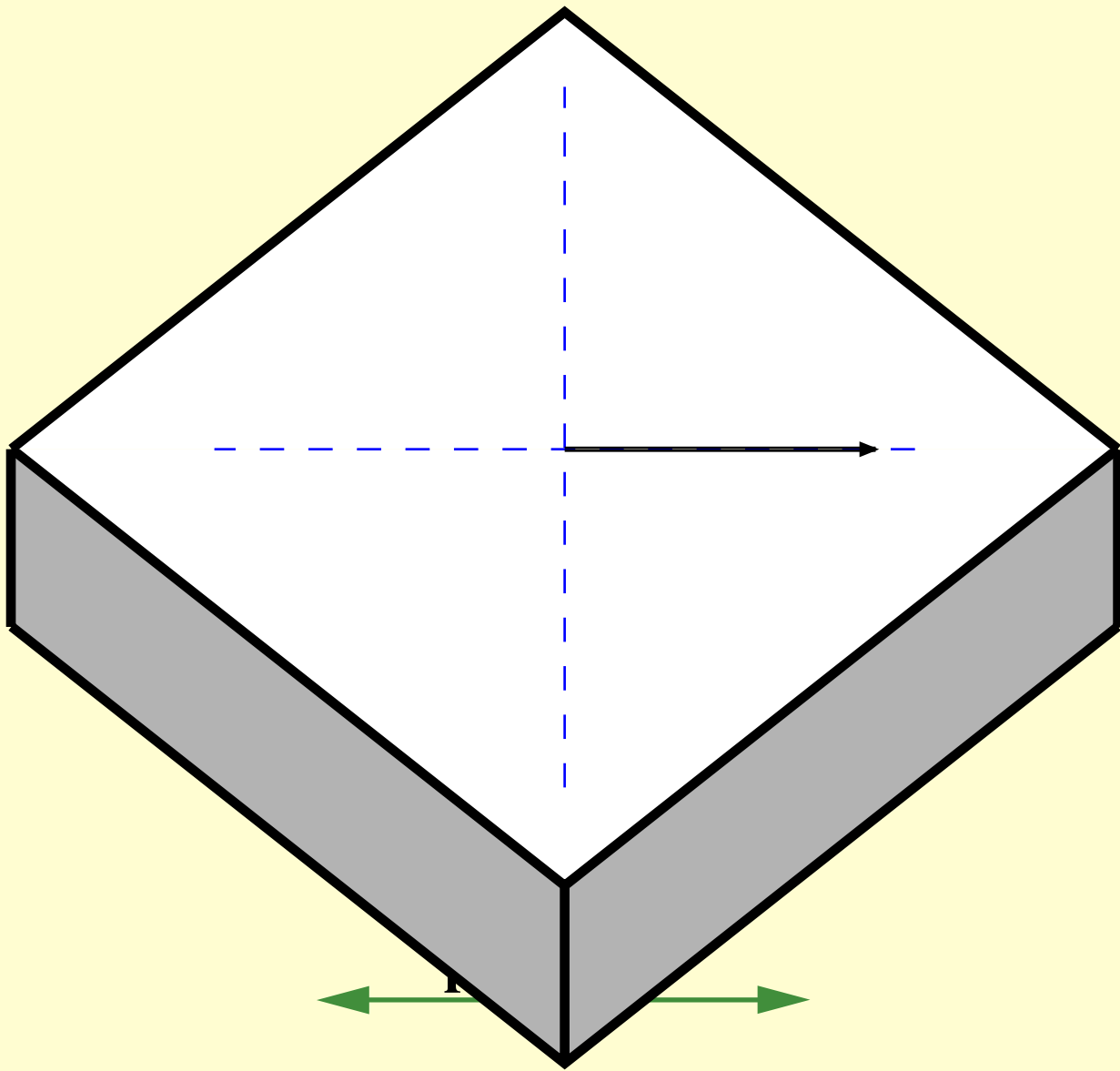

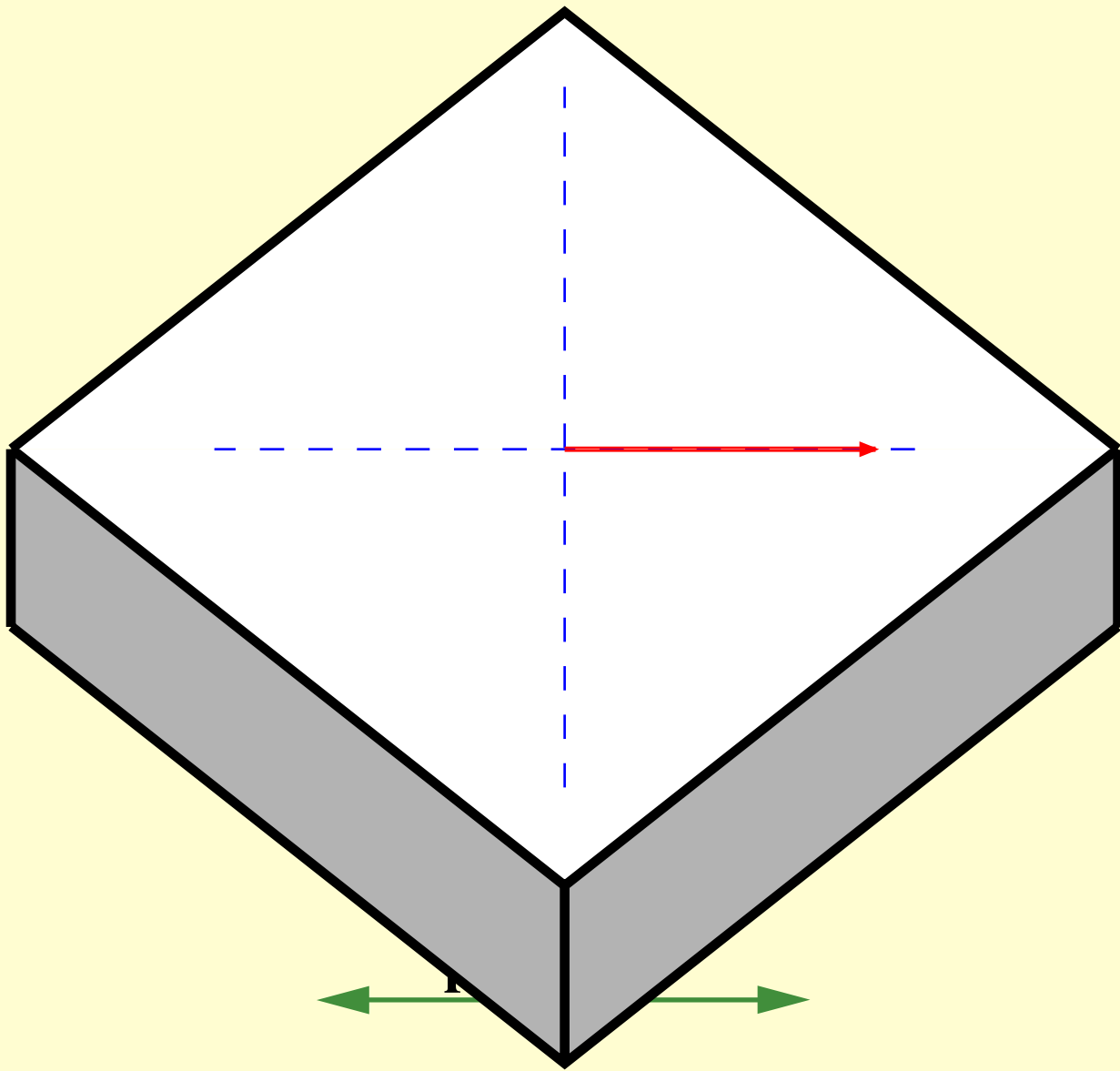

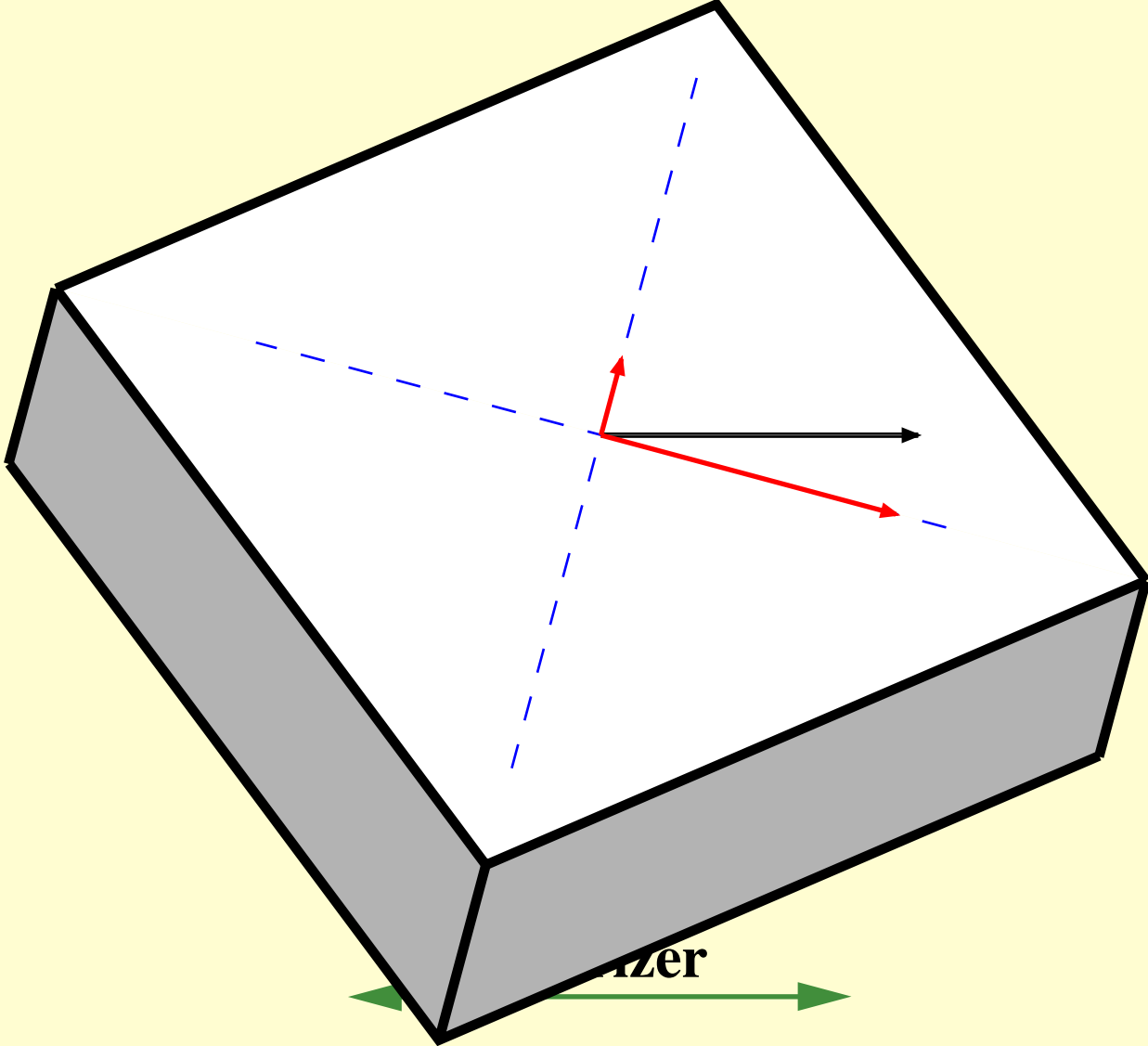

rizer

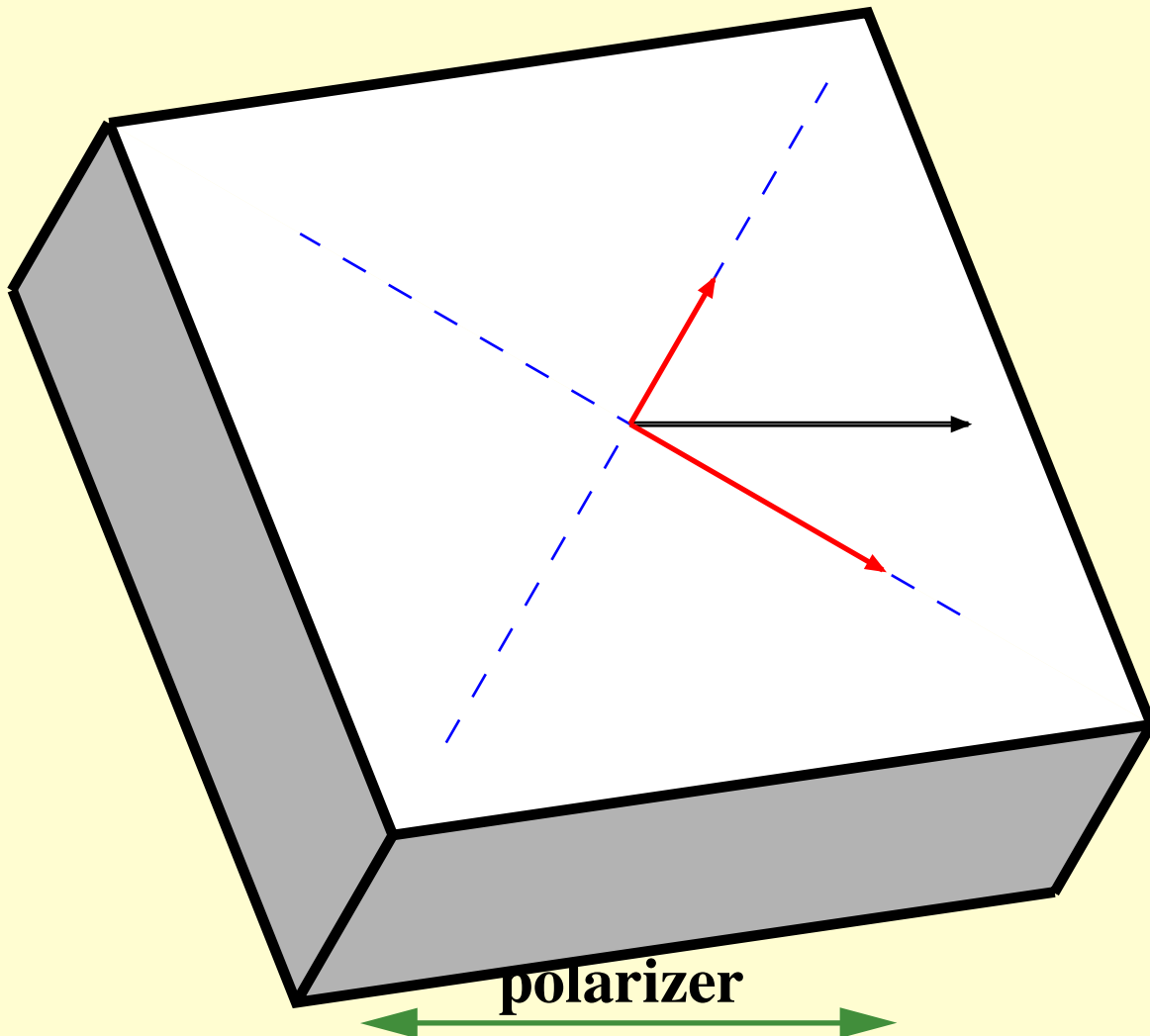

polarizer

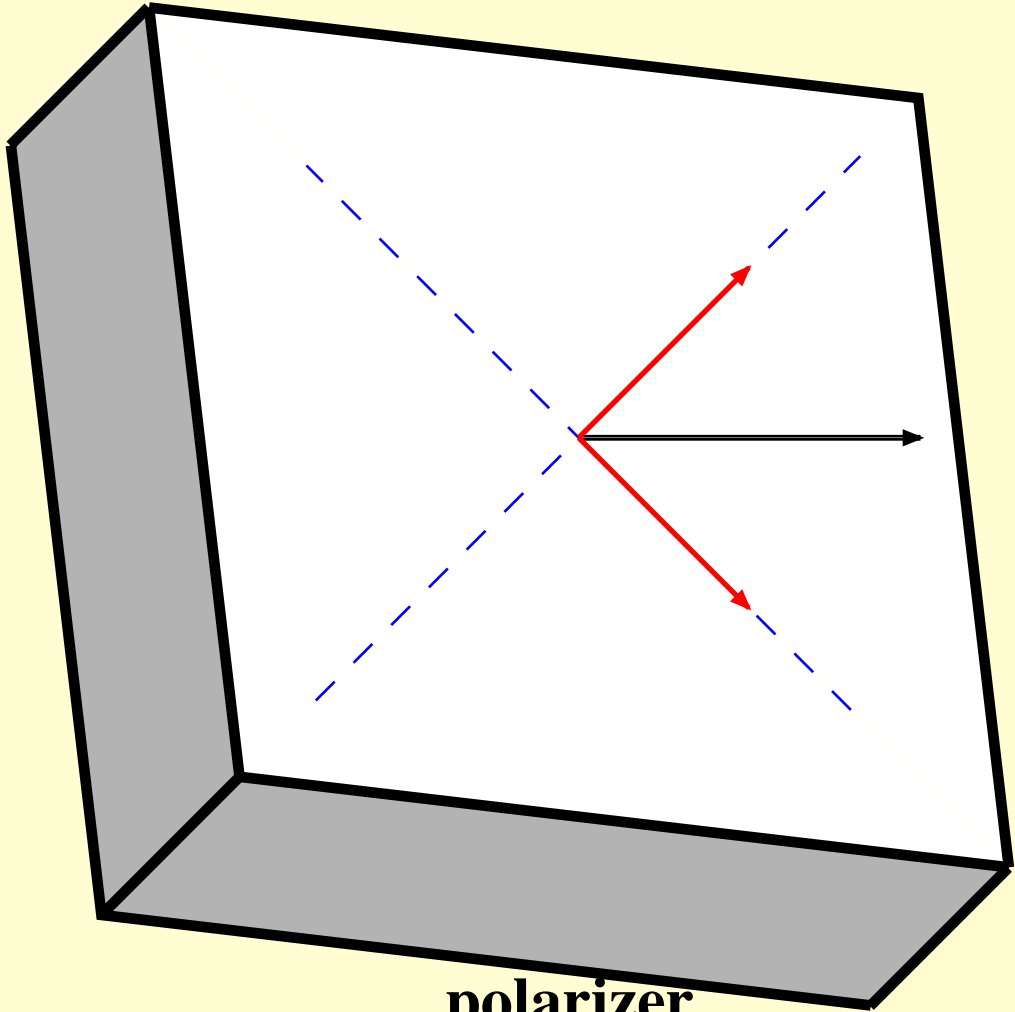

polarizer



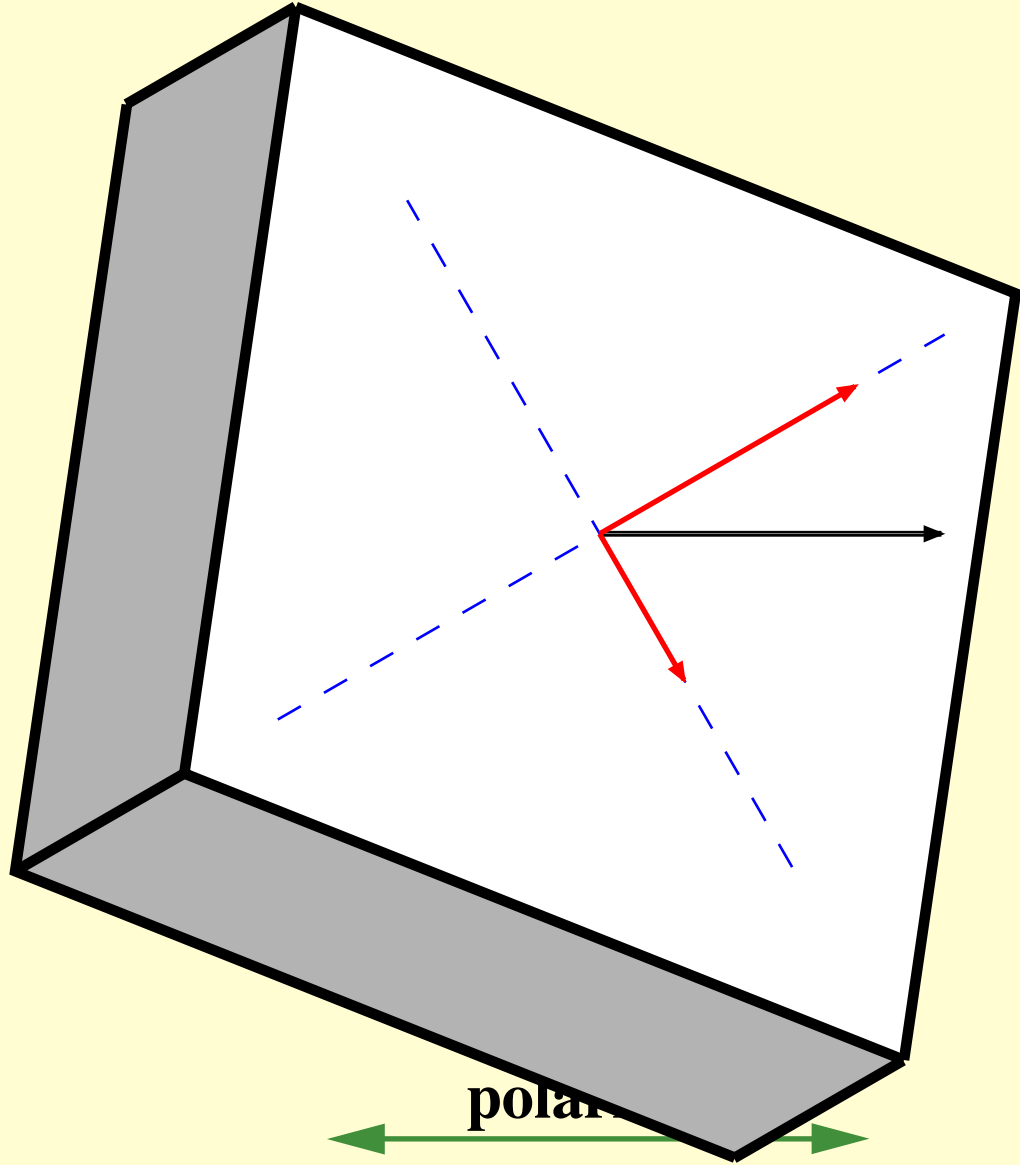

polar

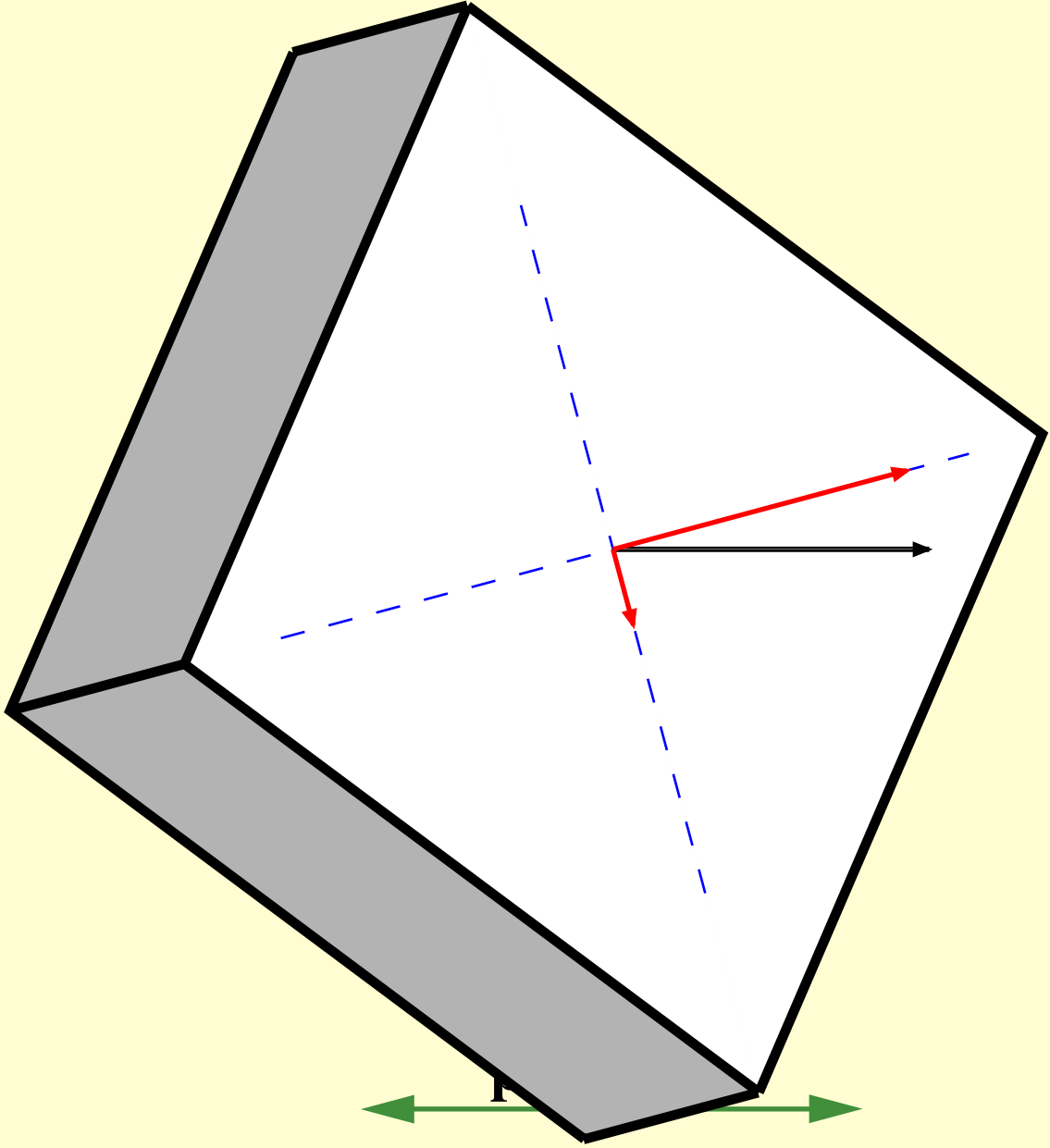

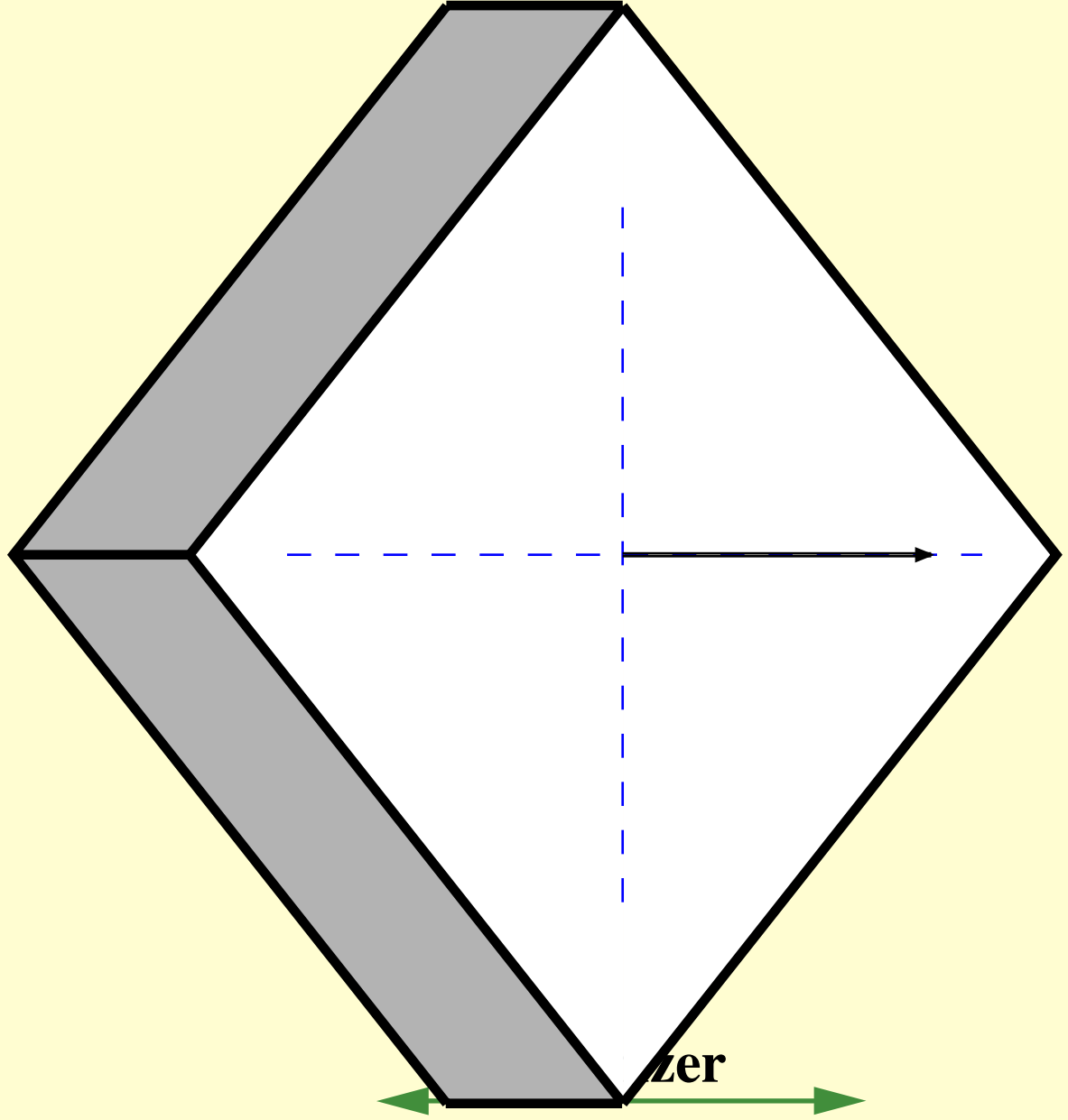

zer

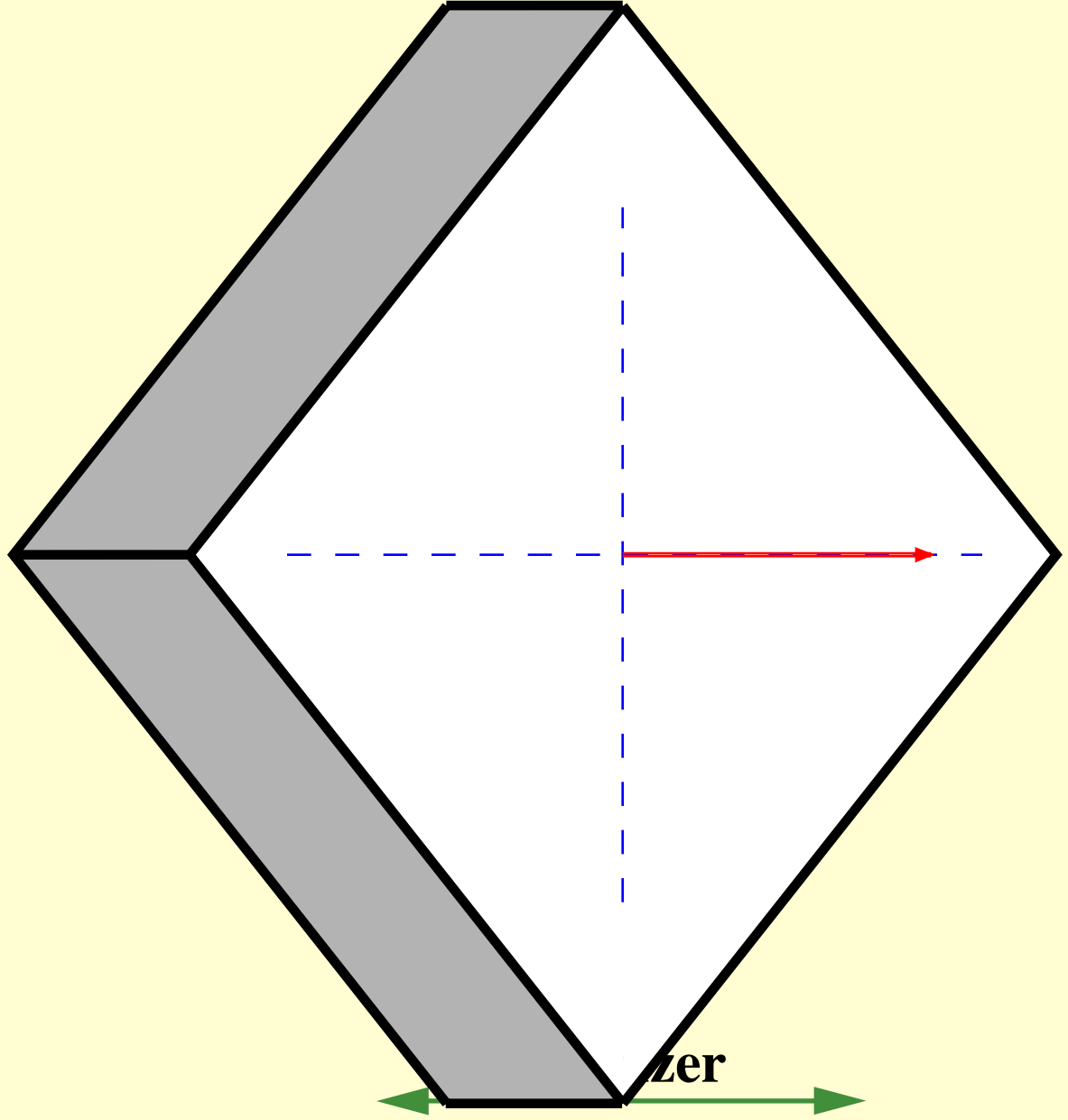

zer

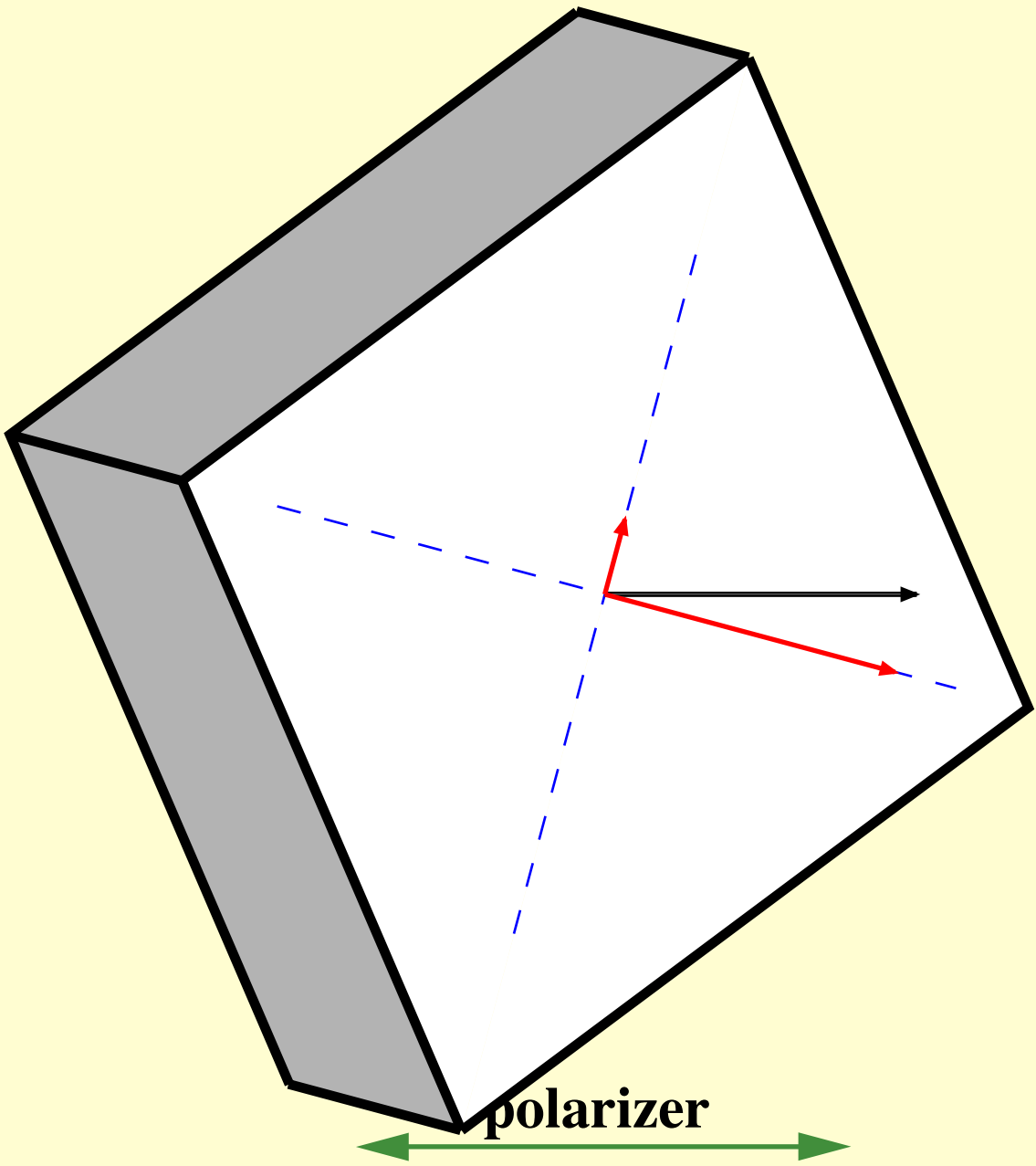

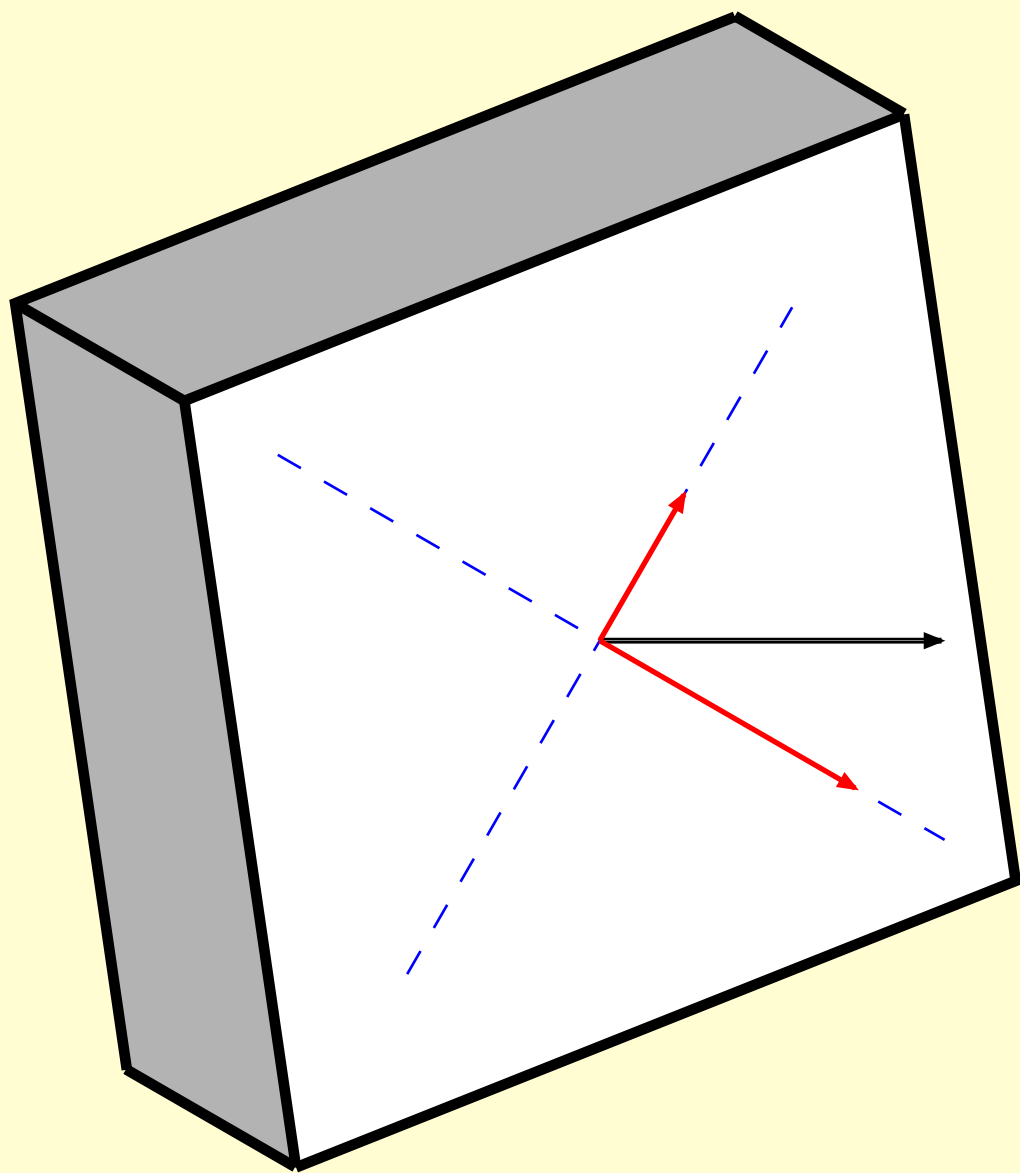

polarizer

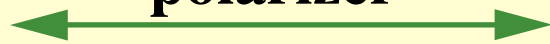

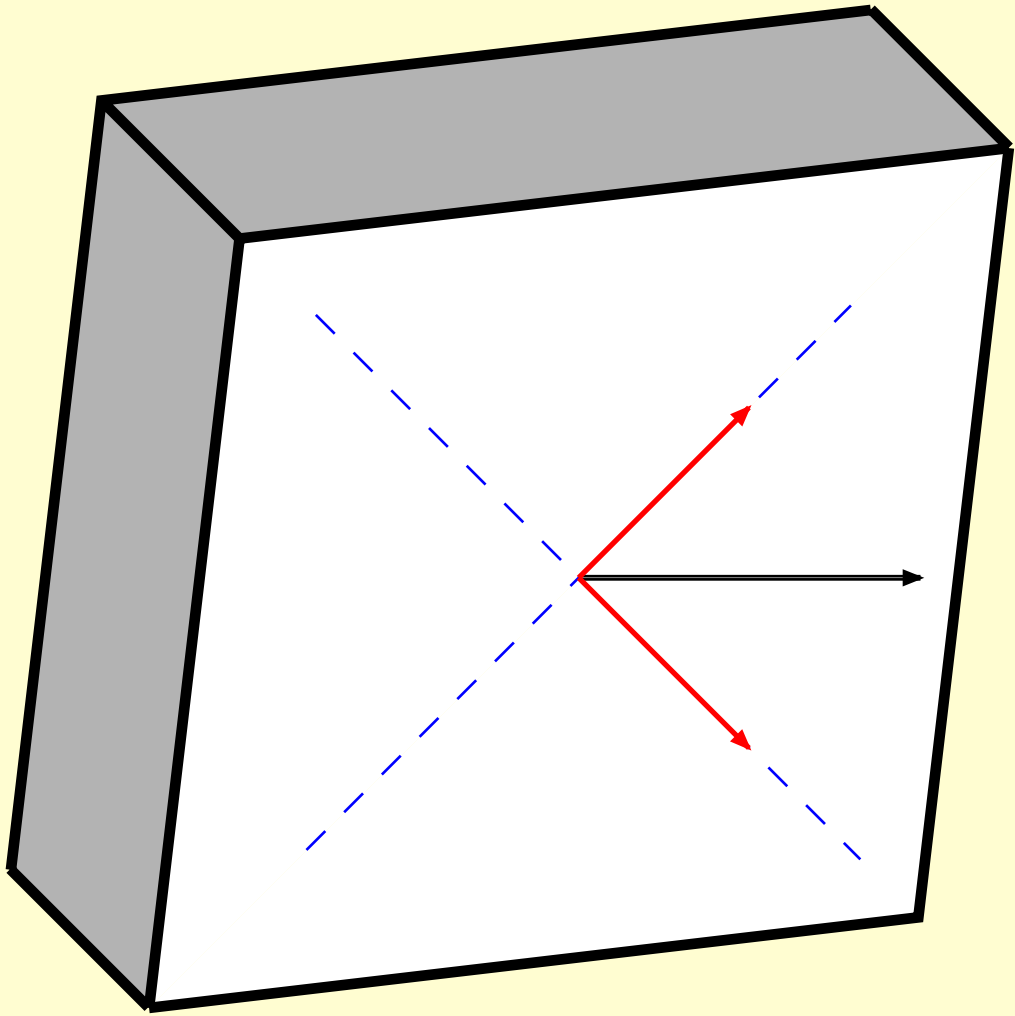

polarizer



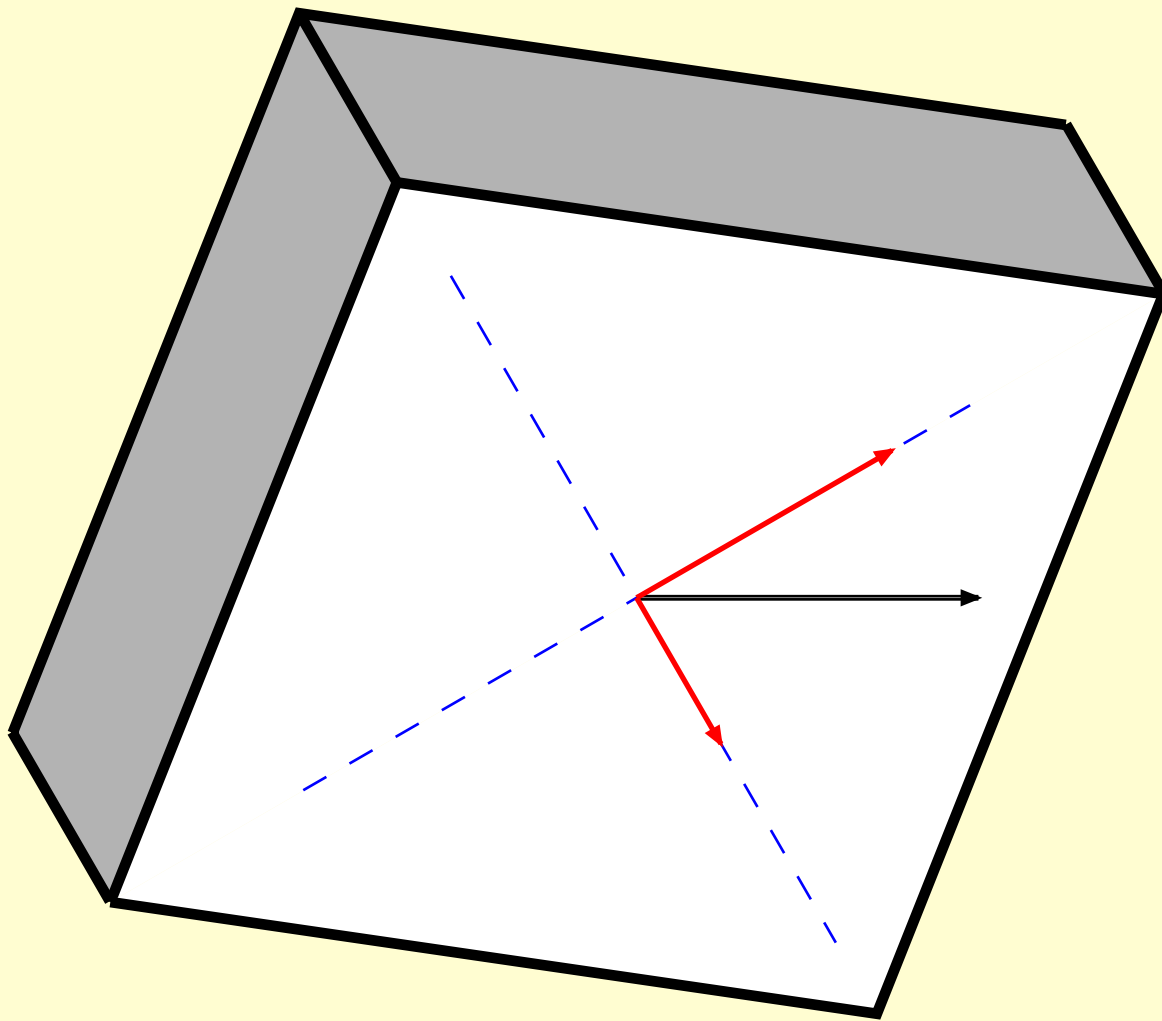

polarizer

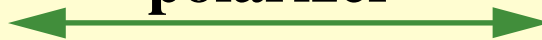

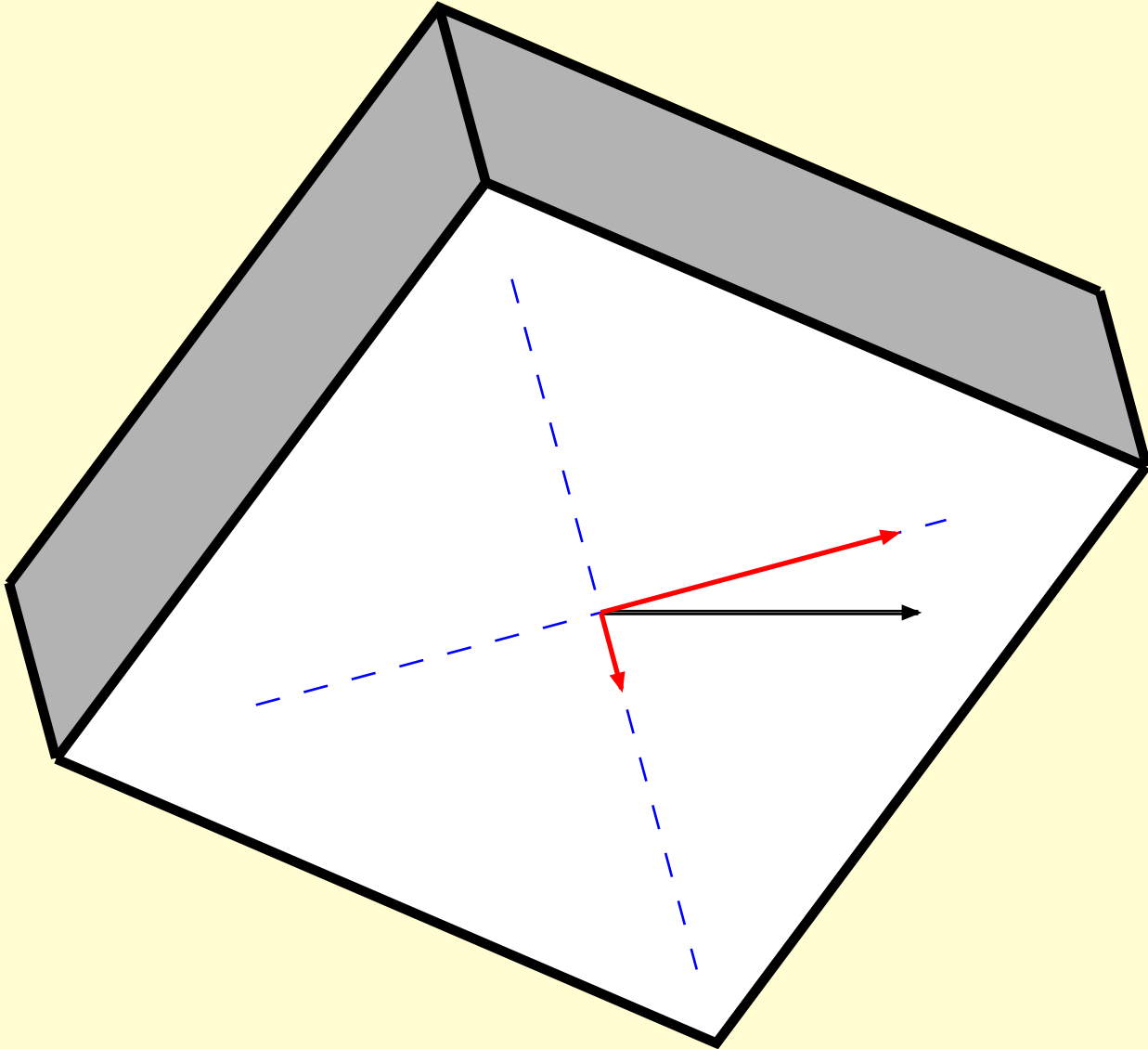

polarizer

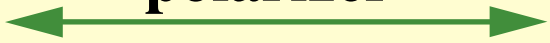

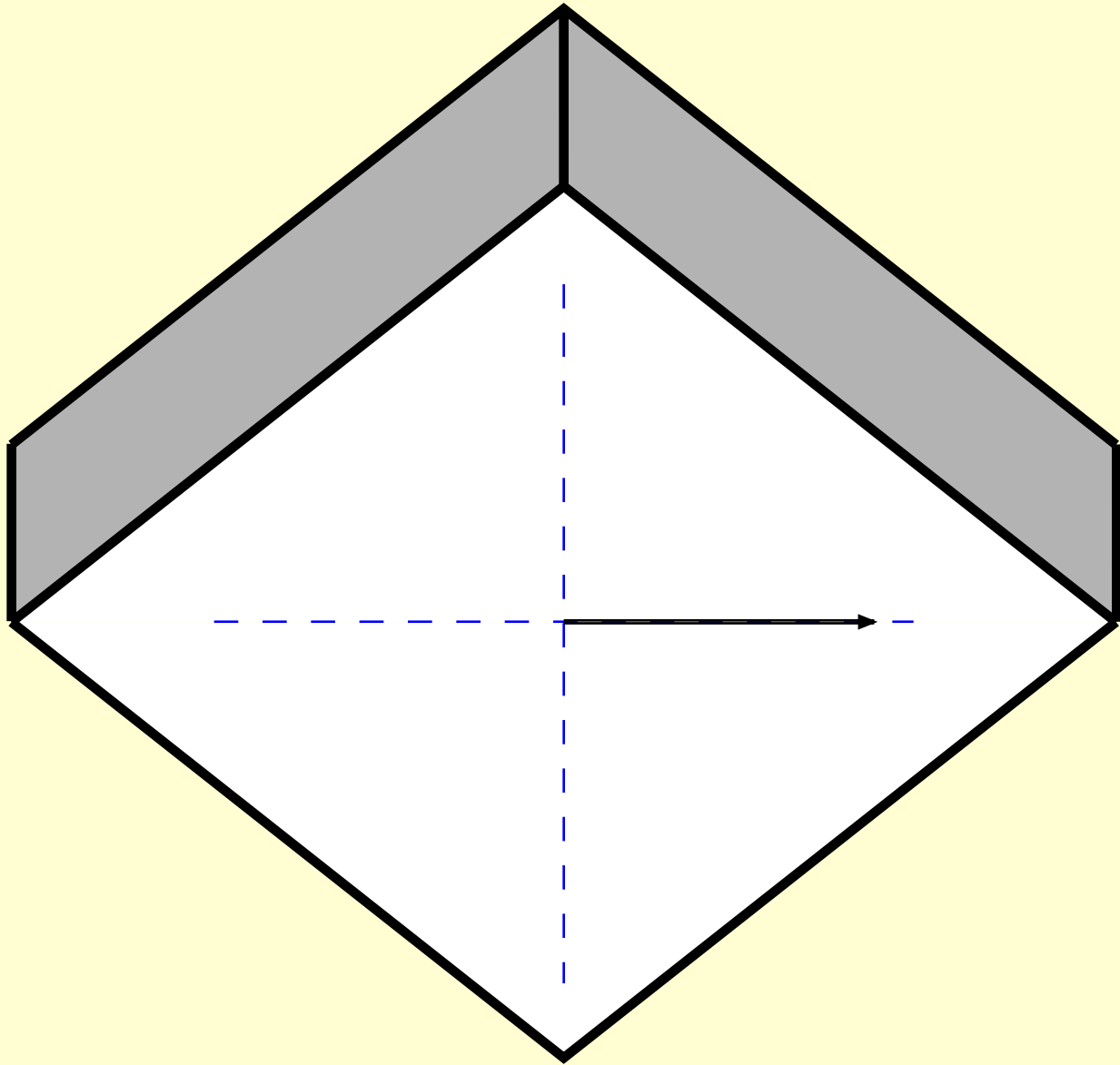

polarizer

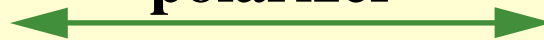

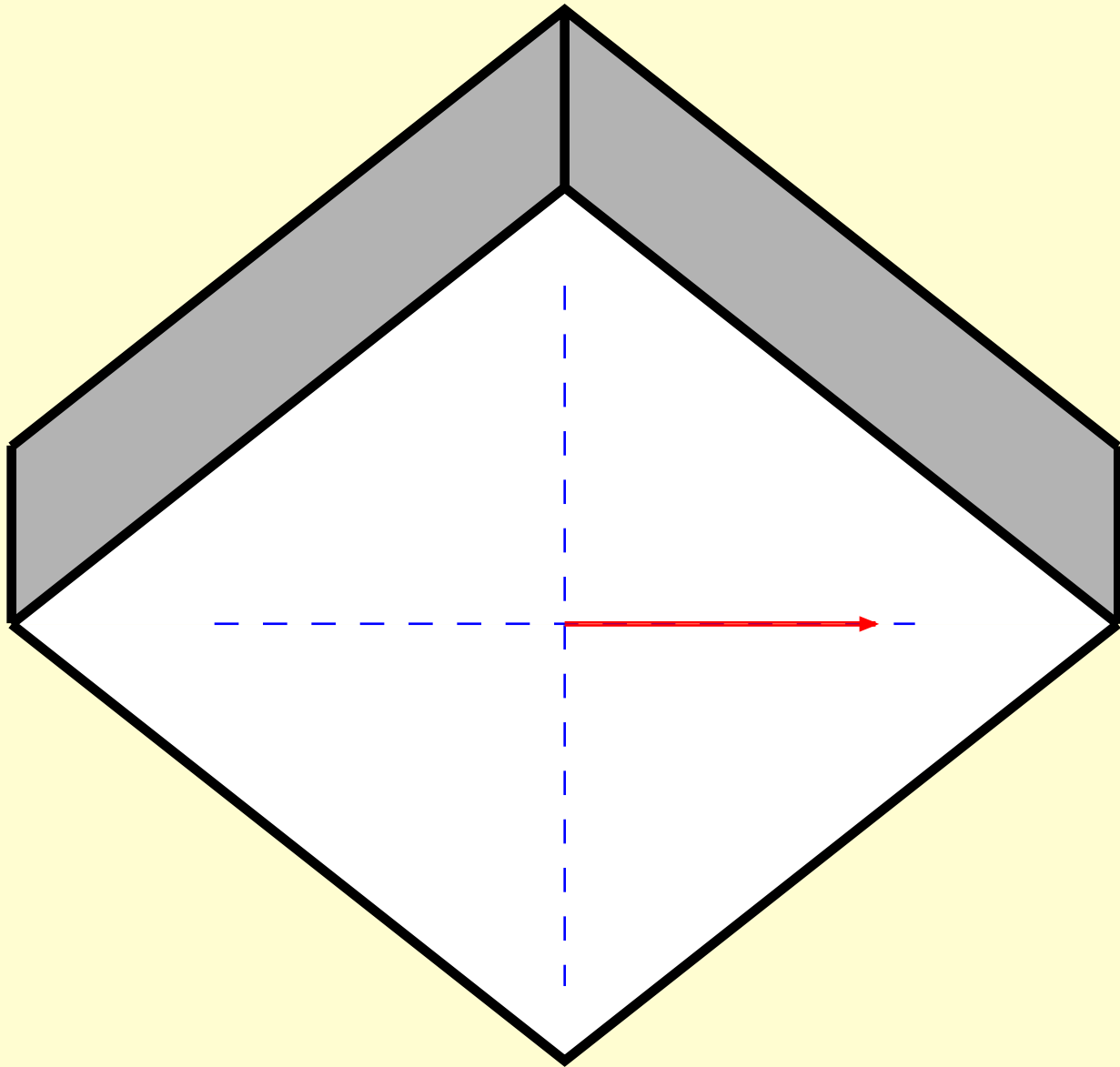

polarizer

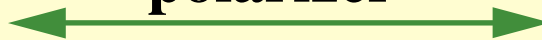

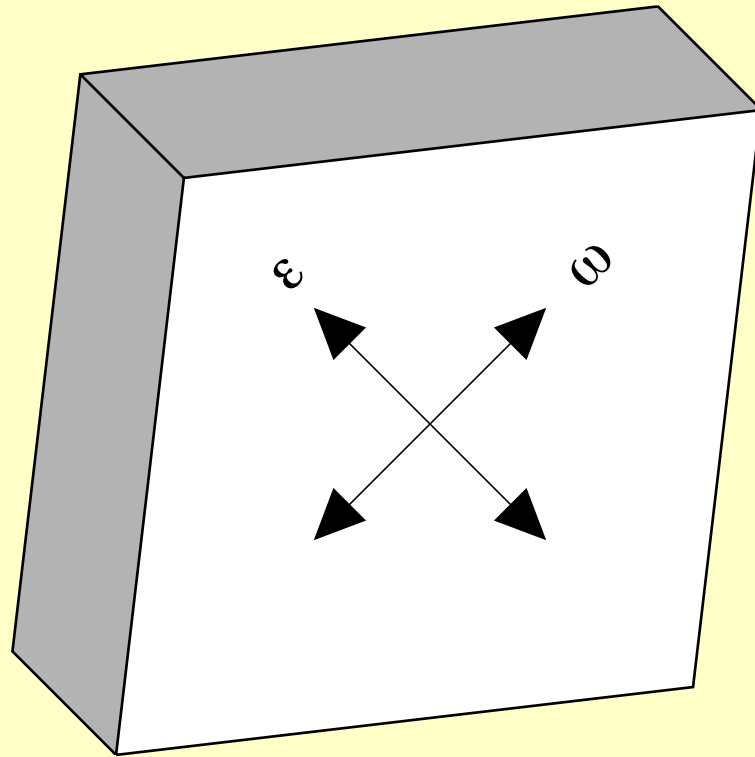

polarizer

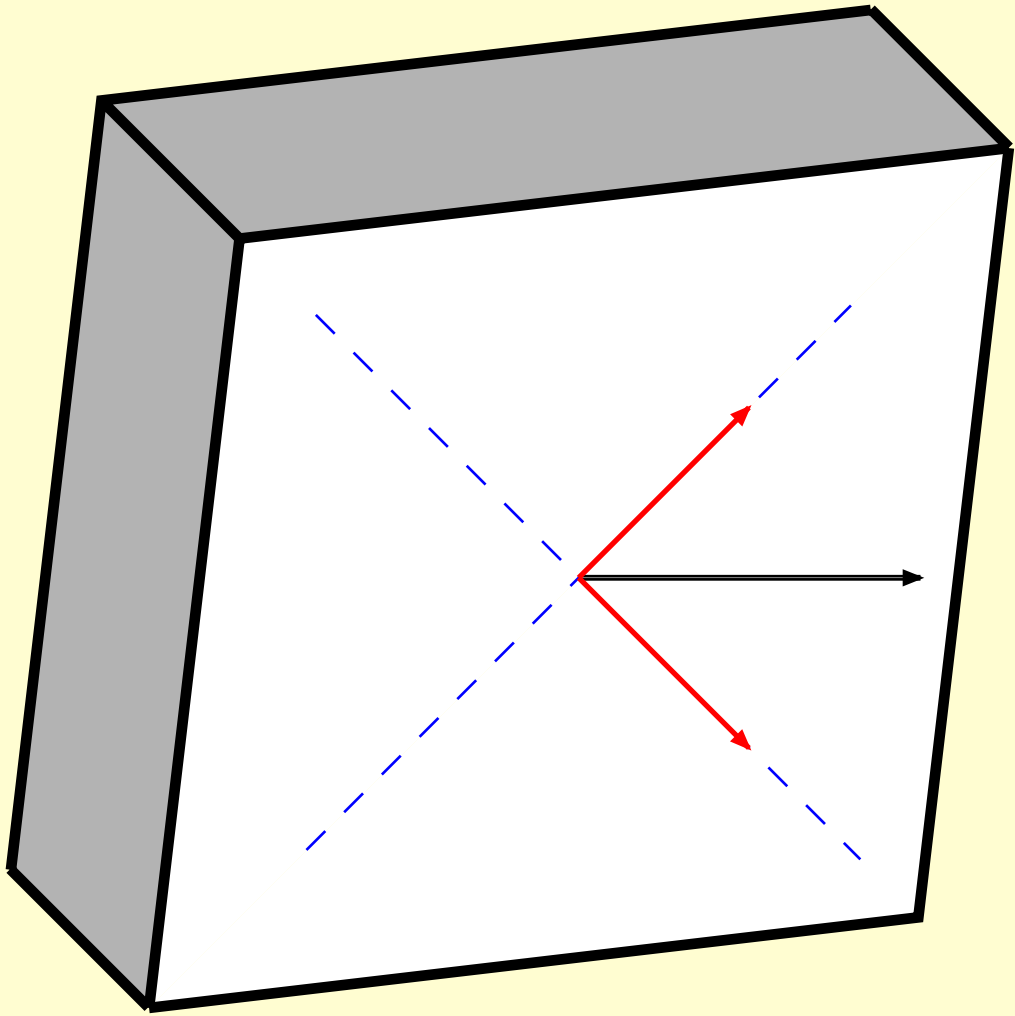

polarizer



crystal 45° from extinction

**vibration
directions**

